

# Breadman®

## 2 LB PROFESSIONAL BREAD MAKER

INSTRUCTION MANUAL

**BK1200SS**



RECIPES INCLUDED

Find more recipes on [WWW.BREADMAN.COM](http://WWW.BREADMAN.COM)

## Please Read and Save this Instruction Manual

# IMPORTANT SAFEGUARDS

When using electrical appliances, basic safety precautions should always be followed including the following:

- Read all instructions.
- Do not touch hot surfaces. Use handles or knobs.
- To protect against electrical shock do not immerse cord, plugs, or appliance in water or other liquid.
- Close supervision is necessary when any appliance is used by or near children.
- Unplug from outlet when not in use and before cleaning. Allow to cool before putting on or taking off parts.
- Do not operate any appliance with a damaged cord or plug, or after the appliance malfunctions or has been damaged in any manner. Contact customer service at the toll-free number listed in the warranty section.
- The use of accessory attachments not recommended by the appliance manufacturer may cause injuries.
- Do not use outdoors.
- Do not let cord hang over edge of table or counter, or touch hot surfaces, including the stove.
- Do not place on or near a hot gas or electric burner, or in a heated oven.

- Extreme caution must be used when moving an appliance containing hot oil or other hot liquids.
- To disconnect, press and hold the **START/STOP** button  for several seconds, remove plug from wall outlet.
- Do not use appliance for other than intended use.
- Avoid contacting moving parts.

## SAVE THESE INSTRUCTIONS

**This product is for household use only.**

### Customer Service:

(US/Canada)  
1-800-231-9786

### Accessories/Parts

(US/Canada)  
1-800-738-0245

For **online customer service** and to **register** your product, go to **[www.prodprotect.com](http://www.prodprotect.com)**



**Caution, hot surfaces: This appliance generates heat and escaping steam during use. Proper precautions must be taken to prevent the risk of burns, fires or other injury to persons or damage to property.**

### **POLARIZED PLUG (120V Models Only)**

This appliance has a polarized plug (one blade is wider than the other). To reduce the risk of electric shock, this plug is intended to fit into a polarized outlet only one way. If the plug does not fit fully into the outlet, reverse the plug. If it still does not fit, contact a qualified electrician. Do not attempt to modify the plug in any way.

### **TAMPER-RESISTANT SCREW**

**Warning: This appliance is equipped with a tamper-resistant screw to prevent removal of the outer cover. To reduce the risk of fire or electric shock, do not attempt to remove the outer cover. There are no user-serviceable parts inside. Repair should be done only by authorized service personnel.**

### **ELECTRICAL CORD**

- a) A short power-supply cord is provided to reduce the risks resulting from becoming entangled in or tripping over a longer cord.
- b) Extension cords are available and may be used if care is exercised in their use.
- c) If an extension cord is used:
  - 1) The marked electrical rating of the extension cord should be at least as great as the electrical rating of the appliance; and
  - 2) The cord should be arranged so that it will not drape over the counter top or tabletop where it can be pulled on by children or tripped over.

**Note:** If the power cord is damaged, please call our customer service line listed in these instructions.

## **POWER OUTAGE**

### **10-Minute Power Failure Back-Up**

Your Professional Bread Maker has a 10-minute power failure back-up feature. If the electricity goes out, the memory will store your cycle selection for up to 10 minutes. If the power comes back on within this time, bread making will resume where it left off.

If the bread maker loses power for more than 10 minutes and you are using any dairy products, perishables or meat in your bread, you should discard the contents of the recipe and start again with new fresh ingredients due to health and sanitary considerations. For nonperishable recipes you may try starting the bread maker at the beginning of the cycle again. However, this may not always produce an acceptable loaf of bread.

If you are not sure when the outage occurred, remove the dough and discard.

Product may vary slightly from what is illustrated.

1. Appliance lid
2. Viewing window
3. Kneading paddle
4. Baking mold
5. Control panel
6. Housing
7. Kneading paddle removal key
8. Measuring cup
9. Measuring spoon

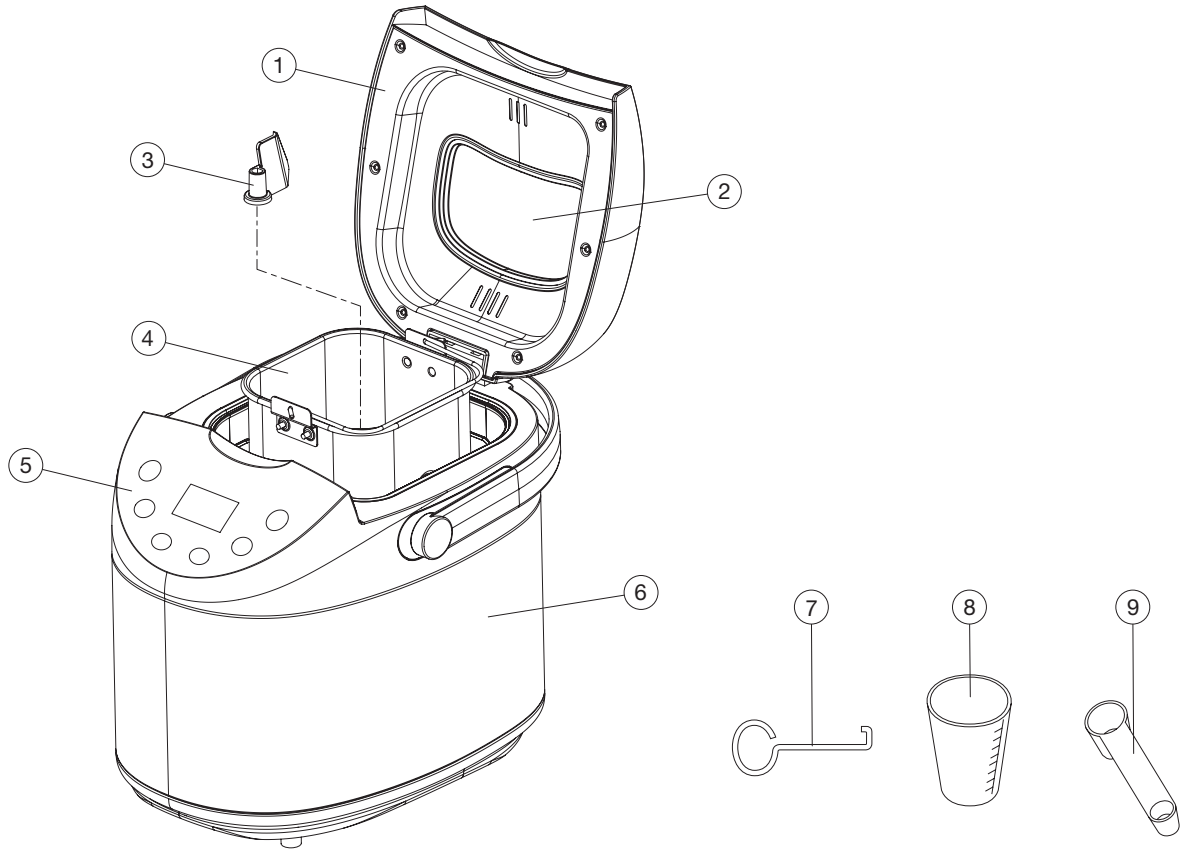

## CONTROL PANEL

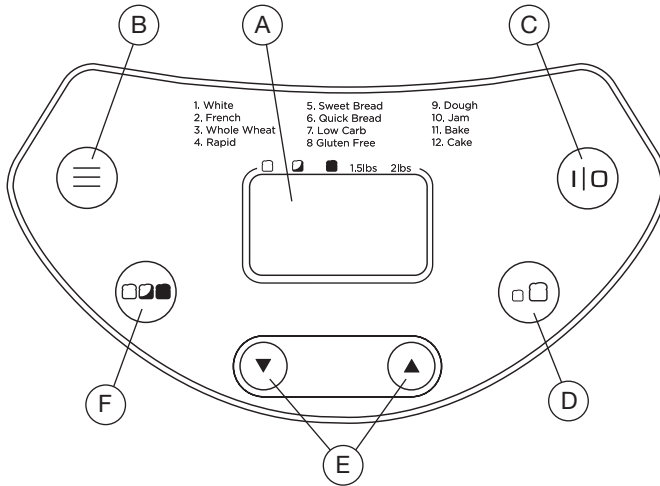

### A. DISPLAY WINDOW





1. Display for selection of the weight (1.5 lb, 2 lb)
2. The remaining baking time in minutes and the programmed time
3. The selected degree of browning (Medium-Dark-Light)
4. The selected program number
5. The program processing sequence

### B. MENU BUTTON

Load the desired baking program. The program number and the corresponding baking time appear on the display.

**Important:** When pressing all touch buttons, an acoustic signal must be audible unless the appliance is in operation.

### C. START/STOP BUTTON

Use to start and stop the operation or to delete a set timer. To interrupt operation, briefly press the **START/STOP** button  until an acoustic signal is heard and the time flashes on the display. By pressing **START/STOP**  again, operation can be resumed. If you do not press **START/STOP**  manually, the machine will resume to process program automatically after 10 minutes. To finish operation and delete the settings, press **START/STOP**  for 3 seconds until one long acoustic signal is audible.

### D. LOAF SIZE BUTTON

Select the gross weight (1.5 lb, 2 lb). Press the button enough times until the marking appears beneath the desired weight.

**Note:** The default setting upon activation of the appliance is 2 lb. The program 4, 6, 7, 9, 10 and 12 can not adjust the loaf size.

### E. TIMER ▲ AND ▼ BUTTONS

Use to add or subtract time for time-delayed baking.

### F. CRUST COLOR BUTTON

Select the degree of browning (Medium-Dark-Light). Press the **CRUST COLOR** button  enough times until a marking appears above the desired degree of browning. The baking time changes depending on the selected level of browning. The program 7, 9, 10, 11, and 12 cannot select the color setting.

**Note:** Do not press the **START/STOP** button  if you only want to check the state of your bread.

# KNEADING AND BAKING CYCLES

**Note:** If at any time during bread making process you need to turn bread maker off, press and hold the **START/STOP** button (11D) for several seconds, then unplug the unit.

**Note:** If bread is not removed immediately after baking and **START/STOP** button (11D) is not pressed, a controlled 60-minute Keep Warm mode will begin (except during Quick Bread, Dough and Jam). For best results, remove bread immediately after baking process is complete.

## 1. WHITE

Used for breads that primarily include white bread flour, although some recipes may include small amounts of whole wheat flour.

## 2. FRENCH

Traditionally, French bread has a slightly crispier crust and lighter texture than white bread. Recipes usually do not include butter, margarine or milk.

## 3. WHOLE WHEAT

Used for recipes with significant amounts of whole wheat or rye flour, oats or bran. Whole wheat cycle begins with rest period during which flours or grains absorb liquid ingredients. Soaking causes flour or grain to soften and helps ingredients to combine. Generally, whole wheat and multi-grain breads are shorter and denser than white, French or sweet.

## 4. RAPID

Used for White, Whole Wheat and French cycles to decrease time to approximately 1 hour. Choose recipe, then simply add ½ tsp. to amount of yeast listed for a 2-lb. loaf. Bread may be shorter and denser than bread made using the longer program.

## 5. SWEET BREAD

Used for recipes that contain eggs, fruit juice, additional sugar or added sweet ingredients such as coconut flakes, raisins, dried fruit or chocolate. Baking temperature is reduced to prevent burning.

## 6. QUICK BREAD

Used for recipes that contain baking powder or baking soda, rather than yeast, to make bread rise. Cake recipes made from scratch must be specially designed for this cycle.

## 7. LOW CARB

Used for recipes that are lower in carbohydrates.

## 8. GLUTEN-FREE

Used for gluten-free recipes.

## 9. DOUGH

Use to prepare dough for making bread, rolls or pizza which are shaped and allowed to rise before baking in a conventional oven. This setting blends and kneads the dough and takes it through the first rise.

## 10. JAM

Use to prepare preserves, marmalade, chutneys and ketchup. Add fruit, sugar and lemon juice for homemade preserves – a great topping for homemade bread, waffles and ice cream.

## 11. BAKE

Used if crust is too light or you wish to bake pre-made dough – also especially useful if your bread is not quite done. Check every few minutes. Bakes for 1 hour.

## 12. CAKE

Used for recipes that contain baking powder or baking soda, rather than yeast, to make bread rise.

# KNOW YOUR INGREDIENTS

FLOUR & OTHER GRAINS	
<b>ALL-PURPOSE FLOUR</b>	All-purpose flour is a blend of refined hard and soft wheat flours ideally suited for making quick breads and cakes.
<b>BRAN</b>	Bran (unprocessed) is coarse outer portion of wheat or rye grains that is separated from flour by sifting or bolting. It is often added to bread in small quantities for nutritional enrichment, heartiness and flavor. It is also used to enhance bread texture.
<b>BREAD FLOUR</b>	Bread flour typically has higher gluten concentration than all-purpose flour. Using bread flour will produce loaves with better volume and structure.
<b>CORNMEAL AND OATMEAL</b>	Cornmeal and oatmeal come from coarsely ground white or yellow corn and from rolled or steel-cut oats. They are used primarily to enhance flavor and texture of bread.
<b>CRACKED WHEAT</b>	Cracked wheat has very coarse texture. It comes from wheat kernels cut into angular fragments. It gives whole grain breads a nutty flavor and crunchy texture.
<b>RYE FLOUR</b>	Rye flour must always be mixed with high proportion of bread flour, as it does not contain enough gluten to develop structure for high, even-grained loaf.
<b>SELF-RISING FLOUR</b>	<u>Self-Rising Flour is NOT RECOMMENDED for use with your bread maker.</u> Self-rising flour contains leavening ingredients that will interfere with bread and quick bread making.
<b>7 GRAIN CEREAL BLEND</b>	7 grain cereal blend is a blend of cracked wheat, oats, bran, rye, cornmeal, flax seeds and hulled millet. It is used primarily to enhance flavor and texture of bread.
<b>VITAL WHEAT GLUTEN</b>	Vital Wheat Gluten is manufactured from wheat flour that has been treated to remove nearly all of the starch to leave a very high protein content. (Gluten is the protein in wheat that makes dough elastic.) Vital Wheat Gluten is available at most health food stores. It can be used in small portions to increase volume and lighten texture.
<b>WHOLE WHEAT FLOUR</b>	Whole wheat flour is milled from the entire wheat kernel, which contains the bran and germ. This high fiber flour is richer in nutrients than all-purpose or bread flour. Breads made with this flour are usually smaller and heavier than white loaves. Many recipes mix whole wheat flour with bread flour or vital wheat gluten to produce higher, lighter-textured bread.



## TIPS ON FLOUR STORAGE

Keep flour in a secure, airtight container. Store rye and whole wheat flours in a refrigerator, freezer or a cool area to prevent them from becoming rancid. Allow flour to come to room temperature before using.

**Note:** Flours, while visibly similar, can be very different in how they are ground, milled, stored, etc. You may have to experiment with different brands of flour to help you make the perfect loaf. See RECIPE TIPS to assist with these experiments.

## YEAST

Active yeast, through a fermentation process, produces carbon dioxide gas necessary to make bread rise. Yeast feeds on carbohydrates in sugar and flour to produce this gas. Three different types of yeast are available: fresh (cake), active dry and quick-acting. Quick, rapid rise and bread machine yeasts are quick-acting. Fresh (cake) yeast is NOT RECOMMENDED for use with your bread maker.

## TIPS ON YEAST

Ensure your yeast is fresh by checking its expiration date. Ideally, yeast should be used several months before the expiration date. Once a package or jar of yeast is opened, it is important that the remaining contents be immediately resealed and refrigerated or frozen for future use. Often dough that fails to rise is due to stale yeast.

**Note:** Basic bread and dough recipes in this booklet were developed using bread machine yeast (active dry yeast). You may use chart to substitute any quick-acting yeast (quick rise or fast rise) for bread machine yeast.

## CONVERSION CHART FOR BREAD MACHINE YEAST

- $\frac{3}{4}$  tsp. bread machine yeast =  $\frac{1}{2}$  tsp. quick-acting yeast
- 1 tsp. bread machine yeast =  $\frac{3}{4}$  tsp. quick-acting yeast
- $1\frac{1}{2}$  tsp. bread machine yeast = 1 tsp. quick-acting yeast
- $2\frac{1}{4}$  tsp. bread machine yeast =  $1\frac{1}{2}$  tsp. quick-acting yeast
- 1 Tbsp. bread machine yeast = 2 tsp. quick-acting yeast

## RAPID CYCLES

Rapid cycle settings for White, Whole Wheat and French decrease time for making your favorite bread in approximately 1 hour. Choose recipe, then add an additional  $\frac{1}{2}$  tsp. of bread machine yeast to the recipe. The bread may be shorter and denser.

## DIFFERENCES IN CLIMATES & BAKING

- In high-altitude areas (over 3,000 feet) dough tends to rise faster, as there is less air pressure. Therefore, less yeast is necessary.
- In dry climates, flour is drier and requires slightly more liquid.
- In humid climates, flour is wetter and will absorb less liquid, so less liquid is required.

## ADDITIONAL INGREDIENT NOTES

**Important: Exact measurements for ingredients are the most important part of baking. It is the key to getting great texture and consistency in your bread. Make sure to measure all ingredients exactly.**

<b>BAKING POWDER</b>	Double-acting baking powder is a leavening agent used in quick breads and cakes. This type of leavening agent does not require rising time before baking, as chemical reaction works when liquid ingredients are added and again during baking process.
<b>BAKING SODA</b>	Baking soda is another leavening agent, not to be confused or substituted for baking powder. It also does not require rising time before baking, as chemical reaction works during baking process.
<b>EGGS</b>	Eggs add richness and velvety texture to bread dough and cakes. When recipe calls for egg(s), large egg(s) at room temperature should be used.
<b>FATS</b>	Butter, margarine and oil shorten or tenderize the texture of yeast breads. French bread gets unique crust and texture from the lack of added fat. However, breads that call for fat stay fresh longer. If butter is used directly from refrigerator, it should be cut into small pieces for easier blending during kneading process.
<b>LIQUIDS</b>	All liquids should be warm 80°F/27°C to 90°F/32°C for all recipes. Liquids, such as milk, water or a combination of powdered milk and water, can be used when making bread. Milk will improve flavor, provide velvety texture and soften the crust, while water alone will produce a crispier crust. Vegetable or fruit juices and potato water may be used for flavor variety.
<b>SALT</b>	Salt is necessary to balance flavor in breads and cakes; it also limits growth of yeast. Changing the amount of salt in a given recipe may result in shorter, gummier bread. When first making a type of bread, do not increase or decrease amount of salt shown in the recipe.
<b>SUGAR</b>	Sugar is important for color and flavor of breads. It also serves as food for yeast since it supports fermentation process. Recipes in this book that call for sugar require granulated sugar. <b>Important: Do not substitute powdered sugar. Artificial sweeteners cannot be used as substitute, as yeast will not react properly with them.</b>

## HOW TO USE

This product is for household use only.

**Important: Your bread maker has an Intelligent Fuse™ system designed to protect the motor from overheating. It will automatically shut off the motor if there is an overheat risk. If this occurs, unplug the appliance, wait a minimum of 20 minutes for it to cool down, and plug in again following the instructions.**

### GETTING STARTED

- Remove packing materials, any stickers, and the plastic band around the power plug.
- Please go to [www.prodprotect.com/breadman](http://www.prodprotect.com/breadman) to register your warranty.
- Place bread maker on dry, stable, level surface away from heat and areas where cooking grease or water may splatter on unit. Do not place near edge of countertop. If placing beneath cabinets, make sure there is enough room to open the lid without interference.

**Important: Your bread maker will bake up at a 2-lb. loaf. Do not put larger quantities of ingredients into bread pan. Bread will not mix and bake correctly and bread maker may be damaged. (See maximum ingredient amounts.**

- Before first use, operate on Rapid White cycle without adding ingredients to burn off manufacturing oils. (Follow instructions in USING YOUR BREAD MAKER.)

**Note:** During first use, bread maker may smoke and/or emit an odor from mineral oils used in manufacturing. This is normal.

## MAXIMUM INGREDIENT AMOUNTS

- Bread cycles: approximately 3 ½ cups
- Quick breads: 3 ½ cups
- Dough cycle: 4 cups
- Jam: 3 cups of fruit mixture

### BREAD PAN TIPS

#### Inserting bread pan

**Note:** Remember to insert kneading paddle first, then add all ingredients in the order listed BEFORE inserting the bread pan into baking chamber.

- This breadmaker has a locking mechanism on the bread pan. When inserting bread pan into bread maker, make sure to rotate the pan to the right to lock it in place (see markings on unit to show direction).

#### Removing bread pan

- To remove bread pan from baking chamber, hold handle with an oven mitt, rotate the pan to the left per markings, and firmly lift straight up.

**Important: When you remove bread pan after baking, be sure to wear oven mitts to prevent burning.**

- After removing loaf (by turning bread pan upside down and shaking gently), check to see that kneading paddle is removed from loaf. If it is stuck in bread, allow bread to cool. Allow bread to cool before removing the kneading paddle.

## CHECKING DOUGH CONSISTENCY

Although your bread maker will mix, knead and bake bread automatically, when baking bread from scratch, it is recommended that you learn to recognize condition of your dough. The ratio of flour to liquid is the most critical factor in any bread recipe, yet the most easily remedied. After 5 to 8 minutes in Knead 2, open bread maker to check consistency of dough. Dough should be in a soft, tacky ball (feel sticky like scotch tape). If it is too dry, add 1 Tbsp. of water at a time. If it is too wet, add 1 Tbsp. of flour at a time.

## USING YOUR BREAD MAKER

**Note:** Depending on the cycle or recipe used, some steps may not apply or there may be additional steps. Refer to the respective recipes instructions in the recipes portion of this booklet, as well as the specific cycle instructions located at the end of these usage instructions.

1. Open lid and remove bread pan. Remove the pan by rotating to the left and lifting straight up.

**Caution: Do not turn or shake bread pan while taking it out. If the bread pan is bent, temperature sensor may not work properly.**

2. Position kneading paddle on the drive shaft. Match flat side of drive shaft to flat part of hole in kneading paddle (A). Make sure paddle is secure.
3. Place ingredients into the bread pan.

**Important: Add ingredients to bread pan in the order listed in the recipe.**

**Important: Always add yeast last.**



4. Make small indentation on top of dry ingredients (not so deep it reaches the wet layer) and add yeast (B).

**Important: Indentation for yeast is important, especially when using the delay bake timer. It keeps yeast away from the wet ingredients until the kneading process begins. (Liquid ingredients will prematurely activate the yeast.)**

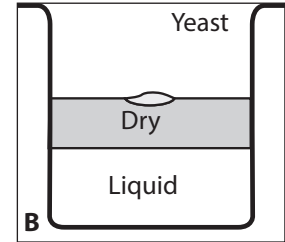

5. Insert the bread pan into the baking chamber (E). Rotate bread pan to the right until it snaps securely into place.
6. Close the lid.

**Important: Do not exceed 2/3 cup capacity.**

7. Plug into standard electrical outlet. Press the **START/STOP** button (⏻) to turn the unit on. Bread maker will beep and program 1 and 3:00 will appear in the display window.
  8. Press **MENU** (≡) to choose desired cycle (C1). Each time **MENU** (≡) is pressed, unit and display will move to the next cycle.
- Note:** As the **MENU** button (≡) is pressed, the numbers on the display will match the numbers of the bread cycles listed on the unit.
9. Press **CRUST COLOR** (☉) to choose crust color (C2). Bread maker is preset for medium crust.

**Note: CRUST COLOR** (☉) will not be activated for the following cycles: Jam, Dough, Bake Only, and Rapid.

10. Press **LOAF SIZE** (C1) to select loaf size (C3). Default size is preset to 2 lb.

**Note:** Loaf size cannot be activated for the following cycles: Jam, Dough, Rapid, Quick Bread, Low Carb, Bake, Cake.

11. Press **START/STOP** button (C2) to begin kneading cycle (C4). The time remaining will begin to count down in display window. Bread making time and loaf size will be shown in display window.

**Note:** During kneading cycle, yeast will activate and viewing window may begin to fog. (This will clear eventually so you can view the progress.)

12. When your bread is finished baking, bread maker will beep and "0:00" will appear in display window. Press **START/STOP** (C2) and open lid. Using oven mitts, remove bread pan.

**Important: Remember, bread pan and loaf are both very hot! Be careful not to place either on tablecloth, plastic surface or other heat-sensitive surface that may scorch or melt.**

**Note:** If bread is not removed immediately after baking and **START/STOP** (C2) is not pressed, the Keep Warm mode will begin. Bread maker will automatically turn off after 60 minutes. For best results, remove bread immediately after baking.

**Note:** Keep Warm does not apply to the following cycles: Jam, Dough.



13. Turn bread pan upside down and shake to release bread (D). Place bread upright on wire rack to cool at least 20 minutes before slicing.

**Note:** The kneading paddle is designed to stay in the bread pan instead of sticking in your bread. Check to see if the paddle stayed in the pan. If not, follow the caution statements below when removing.

**Caution: Be sure to remove the kneading paddle with the removal key from the bread before serving.**

**Caution: Bread pan, kneading paddle and bread will be very hot. Allow bread to cool before removing the paddle.**

14. Press the **START/STOP** button (C2) to turn the unit off. Unplug unit and allow to cool completely before cleaning. (See CARE AND CLEANING INSTRUCTIONS.)

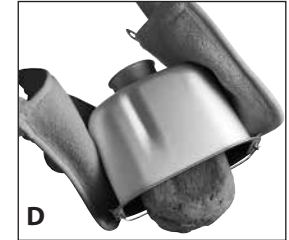

**Important: Make sure to clean the inside of the baking chamber thoroughly after each use.**

15. Once bread has cooled (approximately 2 hours) store in an airtight container.

## SLICING AND STORING BREAD

For best results, place bread on wire rack and allow to cool at least 20 minutes before slicing. Use electric knife or serrated knife for even slices. Store unused bread, tightly sealed (sealable plastic bags or plastic containers work well) at room temperature for up to 3 days. For longer storage, (up to 1 month) place bread in sealed container in freezer. Since homemade bread has no preservatives, it tends to dry out and become stale faster. Leftover or slightly hardened bread may be cut into ½-inch or 1-inch cubes and used in recipes to make croutons, bread pudding or stuffing.

## USING 13-HOUR DELAY BAKE TIMER

**Important: Delay baking does not activate RAPID, QUICK BREAD, or JAM cycles. Do not use delay bake timer if your recipe includes perishables, such as eggs, fresh milk, yogurt or other dairy products and meats, etc. To preset your bread maker, follow these steps:**

To preset your bread maker, follow these steps:

1. Add ingredients in the order listed as usual, taking care not to let yeast and liquid ingredients contact one another.

**Note:** If your recipe contains salt, add it with the liquid ingredients, taking care to keep it away from the yeast.

2. Close bread maker lid and plug it in.
3. Press **MENU** (☰) to select baking cycle. Standard cycle time will be shown in display window.
4. Press ▲ to add time in 10-minute intervals. (Use ▼ to subtract time.) Amount of time set is shown in display window.
  - To fast forward time, continually press ▲.
  - To fast reverse, continually press ▼.
  - For example, if it is 8:00 AM and you want bread ready at 1:00 PM, press ▲ until the display reads 5:00 – meaning it will finish baking in 5 hours. This is the hour difference between 8:00 AM and 1:00 PM.

**Note:** Actual baking times will not change.

5. Press **LOAF SIZE** (🍞) to choose loaf size, press **CRUST COLOR** (🍞) to choose crust color, then press **START/STOP** (▶) to begin timer. The colon (:) in time display begins to flash, letting you know timer is started. When your bread is finished baking, bread maker will beep and “0:00” will appear in display window. Press **START/STOP** (▶) and open lid.

6. If you make an error after you’ve activated program and want to start over, press and hold **START/STOP** (▶) for several seconds. Timer will clear and you can begin again.

## BAKE ONLY

The BAKE ONLY cycle offers the flexibility to vary time. You can bake pre-made dough or dough purchased at the store using this cycle. You may also use this cycle if crust color is too light or if your sweet bread is not quite done. Check every few minutes.

1. Press the **BAKE ONLY** button to activate cycle.
2. Press **START/STOP** button (▶) to begin baking.

## SPECIAL GLAZES FOR YEAST BREADS

Select 1 of the following special glazes to enhance your bread:

- Melted Butter Crust: Brush melted butter over just-baked bread for a softer, more tender crust.
- Milk Glaze: For a softer, shiny crust, brush just-baked bread with milk or cream.
- Sweet Icing Glaze: Mix 1 cup sifted confectioner’s sugar with 1 to 2 tablespoons of milk, water or fruit juice until smooth. Drizzle glaze over raisin or sweet bread when they are almost cool.

**Note:** If desired, generously sprinkle with your choice of nuts or seeds after glazing.

## DOUGH CYCLE

### Tips for Best Results

- If using delay bake timer, make sure yeast is on top of flour, away from liquids.

**Important: Never allow dough to remain in bread maker after cycle is complete; it may over rise and damage machine.**

- Rising times for dough after it is shaped and placed in baking pan will vary due to recipe, temperature and humidity level of your kitchen. Optimum temperature for rising is 80°– 85°F. Rising is the most essential feature in bread making.
- Bread maker allows dough to have first rise or fermentation before dough is removed. Fermentation conditions gluten, (becoming pliable and elastic with a soft, smooth quality) develops flavor and leavens product.
- Sometimes a double rising is beneficial especially for whole grain or 100% whole wheat bread. Let dough rise once in bread maker. Remove from bread maker, punch down, let rise again, punch down and let rest 10 minutes. Resting allows gluten to relax and makes handling easier. Shape as desired and allow to rise until doubled in volume. If only 1 rise is desired, remove from bread maker, let rest, shape and rise as above.
- **Baker's Tip:** Dough has doubled in volume when an indentation remains after tip of a finger is pressed lightly and quickly into dough. If indentation springs back, cover and let rise a few more minutes and check again.

## SPECIAL TIPS FOR MAKING DOUGH

**Important: For use only with the Dough Cycle.**

- Always allow optimum rising of shaped dough.
- Use pastry brush to apply glaze.
- Bake as directed in recipe.

## APPLY JUST BEFORE BAKING:

### Egg Yolk Glaze

For shiny golden crust, mix 1 slightly beaten egg or egg yolk with 1 Tbsp. water or milk.

### Egg White Glaze

For shiny, chewy crust, mix 1 slightly beaten egg white with 1 Tbsp. water.

If desired, sprinkle chopped nuts or fruit and/or seeds after glazing.

### Lightly Floured

Sprinkle enough flour onto work area so dough can be handled without sticking.

### Shaped Rolls

**Important: Once rolls are shaped, cover and let rise until doubled before baking.**

### Cloverleaf Rolls

Shape into ½-inch balls. Place 3 balls in each greased muffin tin.

### Crisscross Rolls

Shape into balls, setting 2 aside. Combine balls and roll into a ⅛-inch thick square. Cut strips ⅛-inch wide and 2-inches long. Brush top of roll with beaten egg. Place 1 strip across top of each ball. Repeat process, placing second strip in opposite direction across top of each ball.

### Traditional Rolls

Shape into balls. For “pull apart” rolls, place dough balls with sides touching in 8 or 9 inch round or square greased baking pan. For “individual” rolls place dough balls 2-inches apart.

### **Crescent Rolls**

On lightly floured board, roll dough to 12-inch circle. Spread with softened butter. Cut into 16 wedges beginning at wider end. Place rolls 2-inches apart on greased baking sheet with points underneath; curve rolls slightly. If desired, brush with melted butter just before baking.

### **Rosettes**

On lightly floured board, roll about 1½ oz piece of dough into 14 inch rope. Tie in a loose knot, leaving 2 long ends. Tuck one end under knot and second end into the top center of the loose knot. Place 2-inches apart on lightly greased baking sheet.

## **JAM CYCLE**

### **Method**

1. Following steps in USING YOUR BREAD MAKER; select **JAM** cycle.
2. Once **JAM** cycle is complete, remove bread pan from bread maker and pour hot mixture into heat-safe jars, leaving ½" of space at the top.
3. Allow to partially cool. Cover tightly to store. Mixture will thicken upon cooling.

### **Tips for Best Results**

- Do not reduce sugar or use sugar substitutes. Exact amounts of sugar, fruit, and other ingredients are necessary for good set.
- Use only ripe fruit (not overripe or under-ripe) for best flavor.
- Do not puree fruit. Jam should have bits of fruit in it.
- Recipes should not exceed 3 cups fruit.
- Remove stems, seeds or pits from fruit.
- You may use strawberries, blackberries, raspberries or other thin

skinned berries. Fruit such as peaches, pears and apricots may be used, but should be peeled and have seeds removed.

- Frozen berries or fruit (no sugar added) may be substituted for fresh. Thaw and drain before measuring. For thinner jam, use juice as part of 3 cups of berry or fruit amount.
- Lemon juice adds necessary acid to berries or fruit.
- You may decrease amount of sugar, but it will produce a thinner result. More sugar will make it thicker. For best results, sugar substitutes are not recommended.
- Average refrigerated life of jam is 2 weeks or up to several months if frozen.

**Important: Do not exceed amounts given in recipes!**



# CARE AND CLEANING

This product contains no user serviceable parts. Refer service to qualified service personnel.

## CLEANING

**Important: Always unplug bread maker and allow to cool completely prior to cleaning.**

Bread pan and kneading paddle have nonstick surfaces, which make cleaning easier.

1. After baking each loaf of bread, unplug bread maker and allow to cool; discard any crumbs.
2. Remove bread pan from oven chamber and kneading paddle from bread pan. Wash bread pan and kneading paddle inside and out with warm, soapy water. Avoid scratching nonstick surfaces.

**Caution: Do not place bread pan in dishwasher, or soak it in water.**

3. If kneading paddle is stuck to drive shaft, pour warm water into bread pan for up to 30 minutes, to loosen it. Do not use excessive force.
4. Wipe inside of lid and oven baking chamber with slightly damp cloth or sponge. If any residue has scorched on heating element or elsewhere, wipe with nonabrasive pad to clean. Lid can be removed for cleaning. Dry baking chamber and lid thoroughly.

**Important: Do not put lid in dishwasher, as it may cause warping. Do not immerse in water, as it contains sensitive electronic sensors.**

5. To clean glass in lid, use glass cleaner or mild detergent and damp cloth or plastic scouring pad. Do not use abrasive cleaners or scouring pads, as they may scratch glass.

6. Do not use vinegar, bleach or harsh chemicals to clean bread maker.
7. Be sure bread maker is completely cooled before storing.
8. Baking chamber contains heating element and drive shaft. When cleaning, NEVER pour water, solvents or cleaning solutions into this area.

## STORAGE

- All removable parts should be thoroughly cleaned and dried.
- Store lid closed. Place bread pan into bread maker with kneading paddle inside.

# TROUBLESHOOTING

QUESTION	ANSWER
Why does height and shape of bread differ in each loaf?	Height and shape of bread may differ depending on the ingredients, room temperature and length of timer cycle. Also, accurate measurement of ingredients is essential to make delicious bread.
Bread has unusual aroma. Why?	Stale ingredients may have been used or too much yeast may have been used. Always use fresh ingredients. Accurate measurements are essential to make delicious bread.
Kneading paddle comes out with bread.	This can happen, as kneading paddle is detachable. <b>Caution: Kneading paddle will be hot. Allow bread to cool before removing kneading paddle with the removal key.</b>
Bread has floured corners.	Sometimes flour in the corners of the bread pan may not have been completely kneaded into dough. Scrape it off the loaf with a knife. Check bread about 10 minutes into kneading cycle. If all flour is not incorporated, use a rubber spatula to remove the flour from the sides of the bread pan so it can be incorporated into the dough.
Can ingredients be halved or doubled?	<b>NO.</b> If there is too little in bread pan, kneading paddle cannot knead well enough. If there is too much, bread rises out of bread pan.
Can fresh milk be used in place of dry milk?	<b>YES.</b> Be sure to decrease same measurement of water to equal liquid substitution. Fresh milk is not recommended when using delay bake timer, because it may spoil while sitting in bread pan.

# HELPFUL HINTS FOR BREAD & DOUGH

## DOUGH BALL (Necessary for a Successful Loaf of Bread)

We have found that liquid amounts called for in a recipe may need to be adjusted slightly because different climates and seasons result in a wide variety of humidity levels. You should check the dough ball at the beep during the kneading process, see program specifications. At this point, the ball should be round, smooth-textured, soft and slightly tacky to the touch. When touched it will leave a little dough on your finger. Push down any dough or flour that may be on the sides of the pan. If it does not form a ball and is more like a batter, add 1 tablespoon of bread flour at a time until it reaches the appropriate consistency. On the other hand, if the moisture is too dry to form a ball, forms more than one ball, or is a ball but not soft and slightly tacky, add 1 teaspoon of water and allow it to absorb. Add more water if necessary. Provided you have used all of the ingredients specified in the recipe, measured the ingredients properly, and have a “good” dough ball, you should achieve a successful loaf of bread.

When preparing bread in the FAST BAKE program, the dough ball will be a very soft, loose ball with a smooth texture and will be sticky to the touch. When touched it will leave dough on your finger.

## BREAD RECIPES . . . AS EASY AS 1 - 2 - 3

- 1.** Add ingredients to the bread pan in the order listed. Refer to Helpful Hints for Bread & Dough for measuring information. Place the bread pan in the Bread Maker.
- 2.** Close the lid. Select the bread program, choose the Crust Color and press Start.
- 3.** When finished baking, remove bread pan from the Bread Maker. Invert and shake to remove the loaf. Allow loaf to cool standing upright on a wire rack before slicing.

We suggest starting your bread baking with the White Bread Recipe. Follow each step carefully. These steps have been written to eliminate the most common errors in Bread Maker baking and may be helpful for any recipe.

## WHITE BREAD

INGREDIENTS	1.5 LB. LOAF	2.0 LB. LOAF
Water (80°F / 27°C)	1 cup	1¼ cups
Oil	2 Tbsp.	3 Tbsp.
Sugar	2 Tbsp.	3 Tbsp.
Salt	1½ tsp.	2 tsp.
Bread Flour	3 cups	4 cups
RED STAR® Active Dry Yeast or	2¼ tsp.	1 Tbsp.
RED STAR® QUICK•RISE® Yeast or	1½ tsp.	2 tsp.
Bread Machine Yeast	1½ tsp.	2 tsp.

### MENU: WHITE

1. Remove the bread pan from the Bread Maker. Attach the kneading blade onto the shaft. Make sure all ingredients, except water, are at room temperature.
2. Use a liquid measuring cup to measure the water (80°F/27°C/baby bottle temperature) and pour into the bread pan.
3. Use a measuring spoon to measure the oil and add to the bread pan.
4. Use a measuring spoon to measure the sugar and salt; level off with the straight edge of a knife and add to the bread pan.
5. Lightly spoon bread flour into a dry measuring cup; level off with the straight edge of a knife and add to the bread pan. Smooth into all corners. Lightly tap pan on counter 3 times to settle all dry ingredients.

6. Carefully measure yeast with a measuring spoon; level off with the straight edge of a knife and add to the bread pan. If using delay timer, make sure yeast is on top of bread flour, away from liquids.
7. Place the bread pan into the Bread Maker. Push down on rim until it snaps into place. Close the lid.
8. Press the **MENU** button to select **WHITE**, select the **LOAF SIZE**, **CRUST COLOR** and set **TIMER** to delay, or press **START/STOP**  button for immediate start.
9. At the beep during the kneading process, check the dough ball. It should be slightly tacky to the touch. Add more water or flour if necessary; see Dough Ball. At this time, push down any dough or flour that may be on the sides of the pan.
10. When the beeper sounds, the bread has finished baking and the keep warm cycle will start. The display window will show 0:00, and the colon will flash.
11. Press Stop and use oven mitts to carefully remove the bread pan at any time during the keep warm process.  
CAUTION: THE OVEN CAVITY, BREAD PAN, KNEADING BLADE AND BREAD WILL BE VERY HOT. USE OVEN MITTS.
12. Turn bread pan upside down and shake several times to release the bread. Do not use metal utensils inside the bread pan or machine. Remove the kneading blade and allow loaf to cool standing upright on wire rack approximately 20-30 minutes before cutting.
13. If bread loaf does not easily release from pan, allow it to sit on a heat resistant surface 5 minutes, then remove. When the bread has completely cooled, approximately 1 hour, store in an air tight container.
14. UNPLUG UNIT BEFORE CLEANING. DO NOT IMMERSER THE BREAD PAN IN WATER, see CLEANING AND STORING.

## PESTO BREAD

INGREDIENTS	1.5 LB. LOAF	2.0 LB. LOAF
Water 80°F/27°C	1 cup	1¼ cups
Pesto, room temperature	3 Tbsp.	¼ cup
Dry Milk	4 tsp.	2 Tbsp.
Sugar	4 tsp.	2 Tbsp.
Salt	¾ tsp.	1 tsp.
Bread Flour	3 cups	4 cups
RED STAR® Active Dry Yeast or	2¼ tsp.	1 Tbsp.
RED STAR® QUICK•RISE® Yeast or	1½ tsp.	2 tsp.
Bread Machine Yeast	1½ tsp.	2 tsp.

### MENU: WHITE

## ITALIAN HERB BREAD

INGREDIENTS	1.5 LB. LOAF	2.0 LB. LOAF
Water 80°F/27°C	1 cup + 2 Tbsp.	1¼ cups
Oil	2 Tbsp.	2½ Tbsp.
Sugar	3 Tbsp.	¼ cup
Salt	1½ tsp.	2 tsp.
Bread Flour	3¼ cups	4 cups
Dried Italian Seasoning	2 tsp.	1 Tbsp.
RED STAR® Active Dry Yeast or	1½ tsp.	2¼ tsp.
RED STAR® QUICK•RISE® Yeast or	1¼ tsp.	1½ tsp.
Bread Machine Yeast	1¼ tsp.	1½ tsp.

### MENU: FRENCH

For best results, use light CRUST COLOR setting.

## 100% WHOLE WHEAT BREAD

INGREDIENTS	1.5 LB. LOAF	2.0 LB. LOAF
Egg, room temperature plus	1	1
enough Water 80°F/27°C to equal	1 cup	1 <sup>1</sup> / <sub>3</sub> cups
Oil	3 Tbsp.	<sup>1</sup> / <sub>4</sub> cup
Sugar	3 Tbsp.	<sup>1</sup> / <sub>4</sub> cup
Salt	1 <sup>1</sup> / <sub>2</sub> tsp.	2 tsp.
Whole Wheat Flour	3 cups	4 cups
Vital Wheat Gluten	1 <sup>1</sup> / <sub>2</sub> Tbsp.	2 Tbsp.
RED STAR® Active Dry Yeast or	2 tsp.	2 <sup>1</sup> / <sub>4</sub> tsp.
RED STAR® QUICK•RISE® Yeast or	1 <sup>1</sup> / <sub>4</sub> tsp.	1 <sup>1</sup> / <sub>2</sub> tsp.
Bread Machine Yeast	1 <sup>1</sup> / <sub>4</sub> tsp.	1 <sup>1</sup> / <sub>2</sub> tsp.

### MENU: WHOLE WHEAT

## HOLIDAY BREAD

INGREDIENTS	1.5 LB. LOAF	2.0 LB. LOAF
Water 80°F/27°C	<sup>1</sup> / <sub>2</sub> cup	<sup>1</sup> / <sub>2</sub> cup
Milk 80°F/27°C	<sup>2</sup> / <sub>3</sub> cup	<sup>3</sup> / <sub>4</sub> cup
Oil	2 Tbsp.	3 Tbsp.
Salt	2 tsp.	2 <sup>1</sup> / <sub>4</sub> tsp.
Sugar	<sup>1</sup> / <sub>4</sub> cup	<sup>1</sup> / <sub>3</sub> cup
Bread Flour	3 <sup>1</sup> / <sub>3</sub> cups	4 cups
RED STAR® Active Dry Yeast or	1 <sup>1</sup> / <sub>2</sub> tsp.	2 <sup>1</sup> / <sub>4</sub> tsp.
RED STAR® QUICK•RISE® Yeast or	1 <sup>1</sup> / <sub>4</sub> tsp.	1 <sup>1</sup> / <sub>2</sub> tsp.
Bread Machine Yeast	1 <sup>1</sup> / <sub>4</sub> tsp.	1 <sup>1</sup> / <sub>2</sub> tsp.
<b>ADD AT THE BEEP:</b> Walnuts, chopped	<sup>1</sup> / <sub>2</sub> cup	<sup>2</sup> / <sub>3</sub> cup
Candied Fruit	<sup>1</sup> / <sub>2</sub> cup	<sup>2</sup> / <sub>3</sub> cup

### MENU: SWEET

## LOW CARB WHOLE WHEAT BREAD (2-LB.)

INGREDIENTS
2 cups water (80°F – 90°F)
¼ cup unsalted butter or margarine, cut in pieces
2 large eggs, at room temperature
2 tsp. lemon juice
1¾ tsp. salt
2½ cups whole wheat flour
½ cup whey protein powder
½ cup vital wheat gluten
½ cup psyllium husk powder
¼ cup flaxseed meal
¼ cup wheat bran
3 Tbsp. nutritional yeast powder
3 Tbsp. oat bran
4½ tsp. bread machine yeast

### MENU: LOW CARB

1. Measure ingredients into bread pan in the order listed.
2. Insert bread pan securely into baking chamber; close lid. Plug unit into wall outlet.
3. Select **LOW CARB**. Press the **START/STOP** (II) button.
4. The complete signal will sound when bread is done.
5. Using pot holders remove bread pan from baking chamber and carefully remove bread from pan. (If kneading paddle remains in bread, remove paddle once bread has cooled.)
6. Allow bread to cool on a wire rack until ready to serve (at least 20 minutes).

**MAKES ONE, 2.0 LB. LOAF**

## GLUTEN FREE BUTTERMILK BREAD (2-LB.)

INGREDIENTS
1¼ cups water (80°F – 90°F)
3 large eggs, at room temperature
¼ cup unsalted butter or margarine, cut in pieces
1 tsp. cider vinegar
2 cups white rice flour
½ cup potato flour
½ cup tapioca flour
¼ cup dry buttermilk powder
¼ cup sugar
¼ cup green onion, chopped
3½ tsp. xanthan gum
1 Tbsp. fresh dill, chopped
1½ tsp. salt
2¼ tsp. bread machine yeast

1. Measure ingredients into bread pan in the order listed.
2. Insert bread pan securely into baking chamber; close lid. Plug unit into wall outlet.
3. Select **GLUTEN FREE**. Press the **START/STOP** (II) button.
4. The complete signal will sound when bread is done.
5. Using pot holders remove bread pan from baking chamber and carefully remove bread from pan. (If kneading paddle remains in bread, remove paddle once bread has cooled.)
6. Allow bread to cool on a wire rack until ready to serve (at least 20 minutes).

**MAKES ONE, 2.0 LB. LOAF**

### MENU: GLUTEN FREE



# QUICK BREAD & CAKE RECIPES

Quick Breads and Cakes are made with baking powder and baking soda that are activated by moisture and heat. The batter is mixed only long enough to blend all the ingredients, then baked immediately.

Full size cake mixes (approximately 18 ounces) and quick bread mixes (approximately 15 ounces) work well using the **QUICK BREAD** program. Add ingredients listed on the package and the **QUICK BREAD** program will mix and bake the pre-packaged cake or quick bread.

It is suggested that all liquids should be 80°F/27°C (water, milk, eggs, oil, butter) and be placed in the bottom of the bread pan, dry ingredients on top. After loading the bread pan in the machine, select the **QUICK BREAD** program.

During the initial mixing of batter, dry ingredients may collect in the corners of the pan. It may be necessary to help the machine mix by using a rubber spatula along corners to avoid flour clumps.

When the cycle is complete, the machine will beep. Before removing pan from bread machine, test quick bread or cake for doneness by inserting a toothpick or cake tester into the top center. Remove the toothpick. If the cake is done, the toothpick will come out clean. However, if there is batter on the toothpick, set the machine on the **BAKE** setting to continue to bake additional time as needed. Check cake after 10 minute increments. Depending on size of quick bread or cake and moistness of the batter, 10-30 additional minutes may be necessary.

Note that the complete **BAKE** cycle is 60 minutes and the machine will indicate 1:00.

When baking is complete, remove the pan from the machine and allow the quick bread or cake to remain in the pan for 10 minutes to “set.” Quick bread or cakes are more fragile than yeast breads. They must sit in the pan before unmolding to allow the steam to subside and the interior of the loaf to become more firm.

Remove the quick bread or cake from the pan and cool on a rack before slicing.

# DOUGH RECIPES

## AS EASY AS 1 - 2 - 3

- 1.** Add ingredients to the bread pan in the order listed. Refer to Helpful Hints for Bread & Dough for measuring information. Place the bread pan in the Bread Maker.
- 2.** Close the lid. Select **DOUGH**. Press **START/STOP**  button.
- 3.** Remove the dough from the bread pan when the beeper sounds. Follow shaping and baking instructions.

If you allow the dough to remain in the Bread Maker after the cycle is complete, it may over rise and damage the machine.

Rising times for dough after it is shaped and placed in a baking pan will vary due to recipe, temperature and humidity level of your kitchen. The optimum temperature of the room for rising is 80°-85°F/27°-29°C. Rising is the most essential feature in bread making. After the dough comes out of the Bread Maker, the dough ferments and rises before punching and resting. The gluten becomes pliable and elastic with a soft, smooth quality. Fermentation conditions gluten, develops flavor and leavens the product.

Dough has doubled in bulk when an indentation remains after the tip of a finger is pressed lightly and quickly into the dough. If the indentation springs back, cover and let rise a few more minutes and check again. After punching down and dividing dough, cover and let rest 10 minutes. Resting allows the gluten to relax and makes handling easier. Then shape the dough as desired.

Sometimes a double rising is beneficial especially for whole grain or 100% whole wheat bread. Let the dough rise once, punch down, let rise again, punch down, let rest 10 minutes and shape.

## **CRUST TREATMENTS (USE ONLY WITH DOUGH PROGRAM)**

Always allow optimum rising of shaped dough. Use a pastry brush to apply glaze. Bake as directed.

Egg Yolk Glaze — For shiny golden crust, mix 1 slightly beaten egg or egg yolk with 1 tablespoon of water or milk.

Egg White Glaze — For a shiny, chewy crust, mix 1 slightly beaten egg white with 1 tablespoon of water.

Lightly Floured — Sprinkle enough flour onto work area so dough can be handled without sticking.

## **SHAPING ROLLS**

Cloverleaf Rolls — Shape into ½ inch balls. Place 3 balls in each greased muffin tin and let rise until double in size.

Crisscross Rolls — Shape into balls. Combine two of the balls and roll into a 1/8 inch thick square.

Cut strips 1/8 inch wide and place one strip across the top of each ball. Repeat this process, placing the second strip in the opposite direction across the top of each ball.

Traditional Rolls — Shape into balls. For “pull apart” rolls, place dough balls with sides touching in a baking pan. For “individual” rolls place dough balls 2 inches apart on a baking sheet.

Egg Yolk Glaze — For shiny golden crust, mix 1 slightly beaten egg or egg yolk with 1 tablespoon of water or milk.

Egg White Glaze — For a shiny, chewy crust, mix 1 slightly beaten egg white with 1 tablespoon of water.

Lightly Floured — Sprinkle enough flour onto work area so dough can be handled without sticking.

### **Pan Sizes For Pull-Apart Rolls**

For a 1.5 LB. (18 rolls) recipe, use two 8 x 8 inch baking pans.

For a 2.0 LB. (24 rolls) recipe, use a 9 x 13 inch baking pan.

## WHOLE WHEAT PIZZA CRUST DOUGH

INGREDIENTS	1 THICK OR 2 THIN CRUSTS
Water 80°F/27°C	1 cup
Oil	2 Tbsp.
Sugar	1 Tbsp.
Salt	1 tsp.
Whole Wheat Flour	1 cup
Bread Flour	1½ cups
RED STAR® Active Dry Yeast or	2 ¼ tsp.
RED STAR® QUICK•RISE® Yeast or	1½ tsp.
Bread Machine Yeast	1½ tsp.

### MENU: DOUGH

#### Method

1. Place on a lightly floured surface. Divide in half and press onto a 12 inch pizza pan, raising edges. Sprinkle each pan with 1 tablespoon of cornmeal if desired. Generously prick dough with a fork. For one 12 inch thick crust do not divide.
2. Bake 400°F/205°C for 10-12 minutes or until edges of crust begin to turn a light golden brown. Remove, add toppings and return to oven to bake an additional 15-20 minutes.

## PIZZA CRUST DOUGH

INGREDIENTS	1 THICK OR 2 THIN CRUSTS	2 THICK OR 4 THIN CRUSTS
Water 80°F/27°C	¾ cup	1½ cups + 3 Tbsp.
Oil	1 Tbsp.	2 Tbsp.
Sugar	1 Tbsp.	2 Tbsp.
Salt	½ tsp.	1 tsp.
Dry Milk	1 Tbsp.	2 Tbsp.
Bread Flour	2¼ cups	4½ cups
RED STAR® Active Dry Yeast or	1 tsp.	2 tsp.
RED STAR® QUICK•RISE® Yeast or	¾ tsp.	1¼ tsp.
Bread Machine Yeast	¾ tsp.	1¼ tsp.

### MENU: DOUGH

#### Method

1. Place on a lightly floured surface. Divide and press onto a 12 inch pizza pan, raising edges.
2. Spread pizza sauce over the dough and sprinkle with toppings.
3. Bake 425°F/218°C for 20 minutes or until crust is golden brown around edges.

## STRAWBERRY KIWI PRESERVES

INGREDIENTS
2 cups strawberries, coarsely chopped
1 cup golden or green kiwi, coarsely chopped
¾ cup sugar
1 Tbsp. fresh lemon juice
1 pkg. ( 1.75 oz.) powdered pectin

### MENU: JAM

1. Measure ingredients in order listed into bread pan.
2. Insert bread pan securely into baking chamber; close lid. Plug unit into wall outlet.
3. Select **JAM**. Press the **START/STOP**  button.
4. The complete signal will sound when the preserves are done.
5. Using pot holders remove bread pan from baking chamber and cool on a wire rack. Carefully pour jam into clean jars.
6. Place in refrigerator to set.
7. Store in refrigerator for up to 3 weeks.

**MAKES ABOUT 3 CUPS**

# RECIPE INDEX

## BREAD

White Bread . . . . .	20
Pesto Bread . . . . .	21
Italian Herb Bread . . . . .	21
100% Whole Wheat Bread . . . . .	22
Holiday Bread . . . . .	22
Low Carb Whole Wheat Bread (2Lb) . . . . .	23
Gluten Free Buttermilk Bread (2Lb) . . . . .	24

## DOUGH

Whole Wheat Pizza Crust Dough . . . . .	28
Pizza Crust Dough . . . . .	28

## JAM

Strawberry Kiwi Preserves . . . . .	29
-------------------------------------	----

## **WARRANTY AND CUSTOMER SERVICE INFORMATION**

### **Two-Year Limited Warranty (Applies only in the United States and Canada)**

For service, repair or any questions regarding your appliance, call the appropriate 800 number listed within this section. Please **DO NOT** return the product to the place of purchase. Also, please **DO NOT** mail product back to manufacturer, nor bring it to a service center. You may also want to consult the website listed on the cover of the manual.

#### **What does it cover?**

- Any defect in material or workmanship provided; however, Empower Brands, LLC's liability will not exceed the purchase price of product.

#### **For how long?**

- Two years from the date of original purchase with proof of purchase.

#### **What will we do to help you?**

- Provide you with a reasonably similar replacement product that is either new or factory refurbished.

#### **How do you get service?**

- Save your receipt as proof of date of sale.
- Visit the online service website at [www.prodprotect.com/breadman](http://www.prodprotect.com/breadman), or call toll-free **1-800-231-9786**, for general warranty service.
- If you need parts or accessories, please call **1-800-738-0245**.

#### **How does state law relate to this warranty?**

- This warranty gives you specific legal rights. You may also have other rights that vary from state to state or province to province.

#### **What does your warranty not cover?**

- Damage from commercial use
- Damage from misuse, abuse or neglect
- Products that have been modified in any way
- Products used or serviced outside the country of purchase
- Glass parts and other accessory items that are packed with the unit
- Shipping and handling costs associated with the replacement of the unit
- Consequential or incidental damages (Please note, however, that some states do not allow the exclusion or limitation of consequential or incidental damages, so this limitation may not apply to you.)

#### **Are there additional warranty exclusions?**

**This warranty shall not be valid where it is contrary to U.S. and other applicable laws, or where the warranty would be prohibited under any economic sanctions, export control laws, embargos, or other restrictive trade measures enforced by the United States or other applicable jurisdictions. This includes, without limitation, any warranty claims implicating parties from, or otherwise located in, Cuba, Iran, North Korea, Syria and the disputed Crimea region.**

120V 60Hz 550W

Distributed by:

Empower Brands, LLC, Middleton, WI 53562

Red Star® is a registered trademark of Lesaffre Yeast Corporation.

Quick-Rise® is a registered trademark of Lesaffre et Compagnie.

Empower Brands, LLC is not affiliated with, endorsed by, or sponsored by Lesaffre Yeast Corporation or Lesaffre et Compagnie.

Breadman® is a Registered Trademark of Empower Brands, LLC.

© 2022 Empower Brands, LLC. All rights reserved.

Made in China.

T22-9003221-A

E 29299