

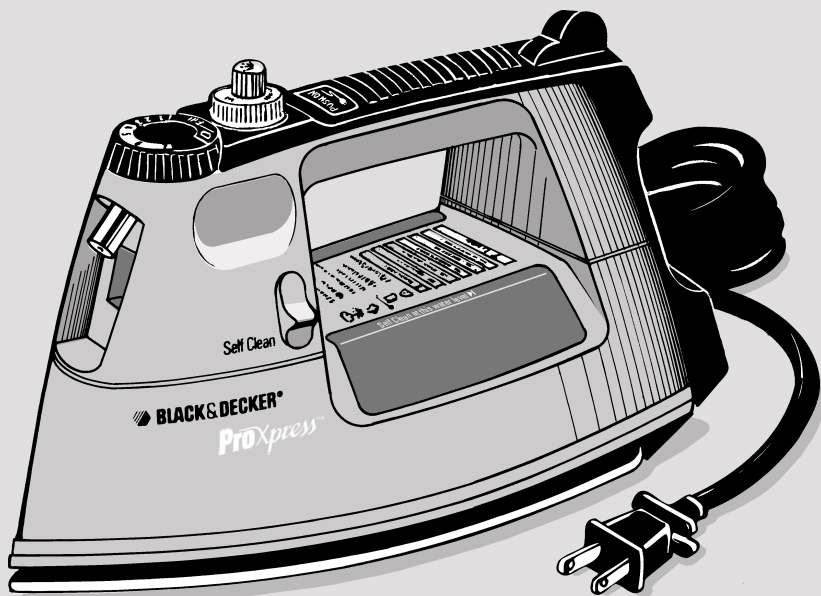

BLACK & DECKER®

SAVE THIS USE AND CARE BOOK

ProXpress™ Automatic Shut-Off™ Iron



800-231-9786

QUESTIONS? Please call us TOLL FREE!
Monday - Friday 8:15 a.m. - 5:00 p.m. Eastern Time.

MODEL F611

IMPORTANT SAFEGUARDS

When using your iron, basic safety precautions should always be followed, including the following:

- Read all instructions.
- Use iron only for its intended use.
- To protect against a risk of electric shock, do not immerse the iron in water or other liquid.
- The iron should always be turned to O/FILL before plugging into or unplugging from an outlet. Never yank cord to disconnect from outlet; instead grasp plug and pull to disconnect.
- Do not allow cord to touch hot surfaces. Let iron cool completely before putting away. Loop cord loosely around cord wrap when storing.
- Always disconnect iron from electrical outlet when filling with or emptying of water and when not in use. Be careful to avoid spilling water over iron when filling.
- Do not press the self clean button while ironing.
- Do not operate iron with a damaged cord or plug or if the iron has been dropped or damaged.
- To avoid the risk of electric shock, do not disassemble the iron; instead, take it to an authorized service center for examination and repair. Incorrect reassembly can cause a risk of electric shock when the iron is used.
- Close supervision is necessary for any appliance being used by or near children. Do not leave iron unattended while connected or on an ironing board. Always position iron carefully to prevent it from falling if ironing board is accidentally moved or cord is pulled. Always use Heel Rest.
- Burns can occur from touching hot metal parts, hot water, or steam. Use caution when you turn a steam iron upside down — there may be hot water in the water tank. Avoid rapid movement of iron to minimize hot water spillage.
- Do not operate in the presence of explosive and/or flammable fumes.
- The use of attachments not recommended or sold by the appliance manufacturer may cause fire, electric shock or injury.
- Do not use iron outdoors.
- This product is for household use only.





SPECIAL INSTRUCTIONS

- To avoid a circuit overload, do not operate another high-wattage appliance on the same circuit.
- If an extension cord is necessary, a 10-ampere rated cord should be used. Cords rated for less amperage may overheat. Care should be taken to arrange the cord so that it cannot be pulled on or tripped over.

SAVE THESE INSTRUCTIONS

POLARIZED PLUG

This ProXpress™ Automatic Shut-Off Iron has a polarized plug (one blade is wider than the other). As a safety feature, this plug will fit in a polarized outlet only one way. If the plug does not fit fully in the outlet, reverse the plug. If it still does not fit, contact a qualified electrician. Do not attempt to defeat this safety feature.

1. Water Fill Hole
2. Spray Nozzle
3. Temperature Selector Dial
4. Indicator Mark
5.  Spray Button
6.  Adjustable Steam/Dry Dial
7.  Self Clean II™ System Button
8. Push On Button
9.  The Extra Long Cord™ (12 foot cord)
10. Cord Wrap/Stable Heel Rest
11. Large Water Windows
12. Full-length Button Grooves
13. Fabric Guide
14.  SilverStone† Soleplate
15. Water Fill Cup - (6 oz. to the bottom of the spout)

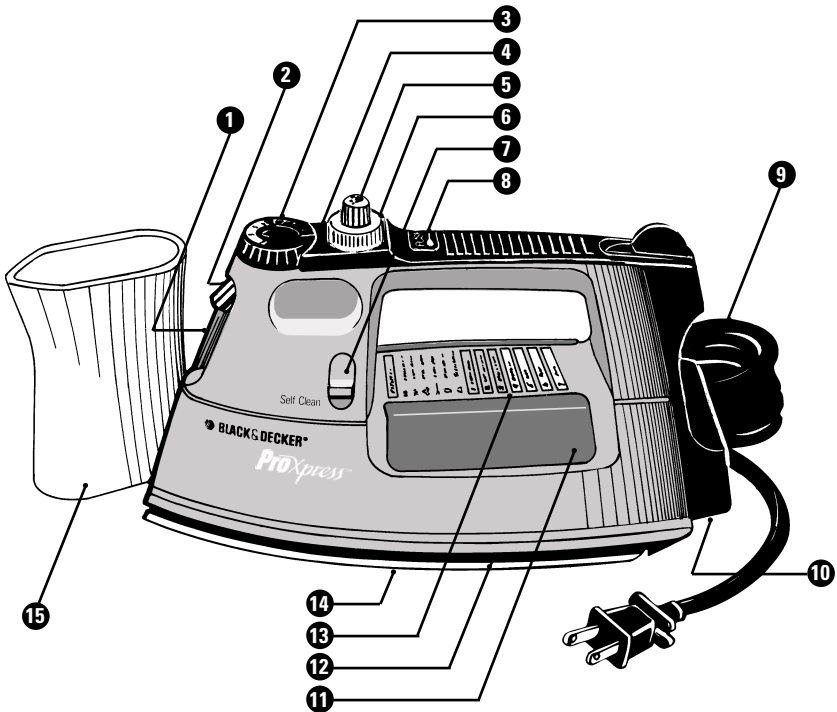

† DuPont SilverStone® premium No-Stick surface

How To Use

PREPARING THE IRON

Important: Follow this procedure to clean the iron and to become familiar with its features.

Remove any labels or tags which may be attached. Using the Water Fill Cup we have provided, fill the Water Tank about 1/3 full with water. (See "Filling With Water," page 5.)

Set the Temperature Selector Dial to the Indicator Mark choosing Cotton or Linen settings (6 or 7) and preheat for about 2 minutes. (See "Starting The Iron," page 5.)

While ironing on an old cotton terry cloth towel for about two minutes, try using each of the iron's features.

SPRAY



Pump the Spray Button a few times to see the amount of water that is released. (See Figure F, page 7.)

STEAM SETTINGS



Turn the Adjustable Steam/Dry Dial to the Indicator Mark for ☁ (light), ☁☁ (medium), and ☁☁☁ (heavy) settings to become familiar with the various settings. Use the self-cleaning feature as described on page 9. Iron on the towel for another minute or two.

FILLING WITH WATER

Using the Water Fill Cup we have provided, pour water into the Water Fill Hole until the water level reaches the full mark on the Water Window. (Figure A) Do not overfill. Refill as necessary.

Ordinary tap water can generally be used for ironing. However, do not use water processed through a home softening system.

In extremely hard water areas (over 180 parts per million) consider using distilled or demineralized water. If using distilled or demineralized water, tap water should be used the first time you use the iron and once per month thereafter to maintain steam performance.

STARTING THE IRON

Plug in the iron. After setting the Temperature Selector Dial at the Indicator Mark for the desired temperature, press the PUSH ON Button. (Figure B)

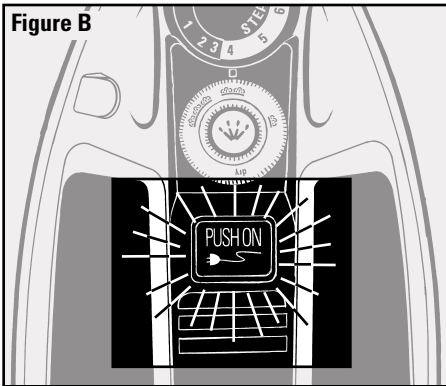

If the iron is turned on and left sitting motionless in the Heel Rest position for 9 minutes, the TEMPERATURE READY Light will flash to alert you it's about to shut itself off.

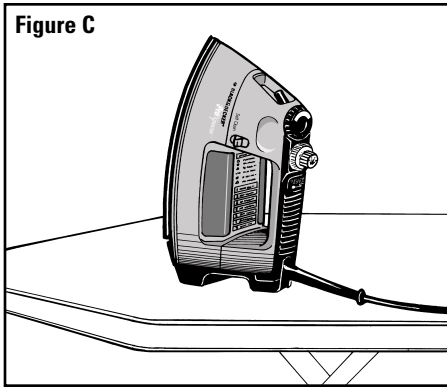

If unremoved for 1 additional minute, it will shut itself off completely. (Figure C) To restart the iron, be sure the Temperature Selector Dial is in a position other than 0/Fill and press the PUSH ON Button.

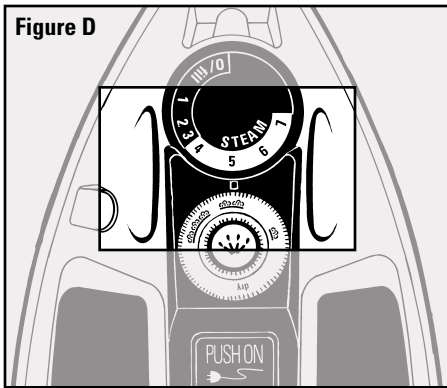

USING MOISTURE

Steam



Turn the Adjustable Steam Dial to the Indicator Mark (Figure D) for ☁☁ (light), ☁☁☁ (medium), or ☁☁☁☁ (heavy) steam settings as indicated next to the Temperature Settings 4-7 on the saddleplate. If water spotting occurs, reduce the steam level and/or increase the heat setting on the Temperature Selector Dial.

☁☁☁☁ (heavy) steam settings as indicated next to the Temperature Settings 4-7 on the saddleplate. If water spotting occurs, reduce the steam level and/or increase the heat setting on the Temperature Selector Dial.

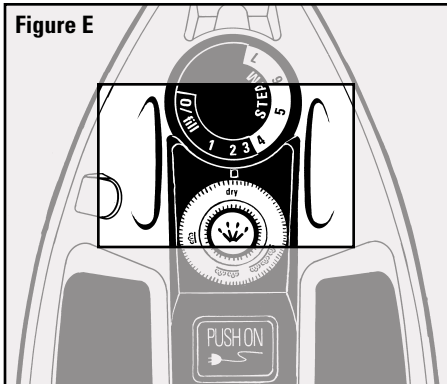

DRY

Turn the Adjustable Steam/Dry Dial to Indicator Mark for DRY to iron without steam. (Figure E) You may iron without steam at any temperature setting.

Figure F

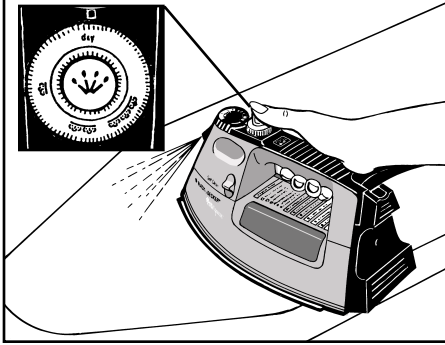

Spray



Pump the Button a few times to get a water mist from the spray nozzle to spot dampen stubborn wrinkles. (Figure F)

Figure G

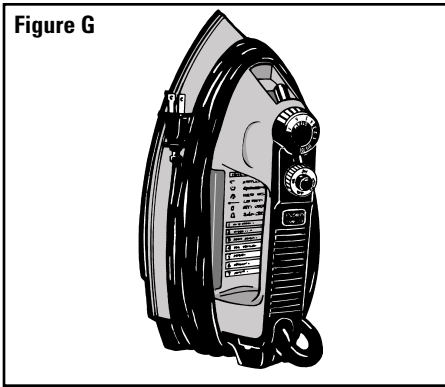

STORING THE IRON

Turn the Adjustable Steam Control to DRY and turn the Temperature Selector Dial to 0/Fill. Unplug the iron. Allow the iron to cool and wrap the cord.

(Figure G) It is not necessary to empty the water if the iron is used frequently, but **the iron must be stored on its Heel Rest** to prevent water leaking from the Soleplate and causing damage to the Soleplate.

FABRIC IRONING CHART

Refer to this chart for recommended Temperature and Steam Settings and ironing instructions for various fabrics. Always read garment labels and follow manufacturer's ironing instructions.

FABRIC	ADJUSTABLE STEAM	TEMP.	IRONING INSTRUCTIONS
ACRYLIC ACETATE		1.	Dry iron on wrong side. Press washables while damp.
NYLON SILK		2.	Dry iron on wrong side to prevent shine. Press washables while damp.
POLYESTER SOME RAYONS PERM. PRESS		3.	Dry iron washables while fabric is damp. Iron rayon fabrics on the wrong side. Steam iron if fabric manufacturer directs.
COTTON BLENDS		4.	Check care label and follow the manufacturer's instructions for blends: use the setting for the fiber requiring the lowest heat.
WOOL		5.	Steam iron on wrong side to prevent shine, or use a press cloth on right side. Do not press completely dry.
COTTON		6.	Dry iron washables while damp. Use steam as needed. Iron dark fabrics on wrong side to avoid shine.
LINEN		7.	Dry iron washables while damp and until dry. Use steam as needed. Iron dark linens on wrong side to avoid shine.

NOTE: USE **SPRAY** FEATURE AT ANY TEMPERATURE SETTING. **STEAM** SHOULD ONLY BE USED IN STEAM AREA OF THE TEMPERATURE SELECTOR DIAL. WATER SPOTTING MAY OCCUR IF THE SETTING IS TOO LOW.

CARE OF THE IRON

Figure H

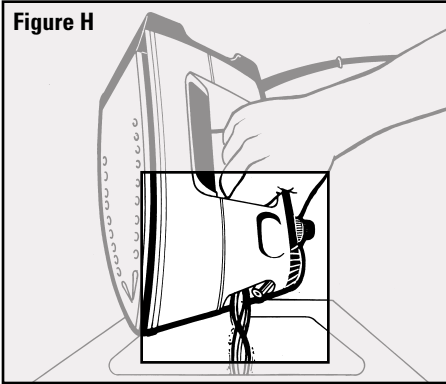

EMPTYING THE IRON

Turn the Temperature Selector Dial to the Indicator Mark for O/Fill, set the Adjustable Steam Dial to the Indicator Mark for the Dry position, and unplug the iron. Empty the water by holding the iron over a sink with the tip pointing downward (Figure H). Water will empty out the Water Fill Hole.

CLEANING THE OUTSIDE SURFACES

Allow the iron to cool completely. Wipe the outer shell and SilverStone† Soleplate finish with a cloth dampened in water and a mild household detergent. Never use abrasive, heavy-duty cleansers or scouring pads. After cleaning, steam iron on an old, cotton terry cloth towel for approximately 2 minutes.

SELF CLEANING



About once a month use the Self Clean feature to flush out water, minerals, and lint. If lint is allowed to accumulate in the vents, it can scorch and cause troublesome brown spotting. Do not be alarmed if hissing and spitting occurs while self cleaning. This is normal.

With the Water Tank filled to the Self Clean Level and the iron sitting on its heel rest, turn the Temperature Selector to the highest temperature setting and push the PUSH ON Button. The Steam/Dry Dial can be in either position. Turn the Temperature Selector to O/Fill and unplug the iron.

† DuPont SilverStone® premium No-Stick surface

Figure I

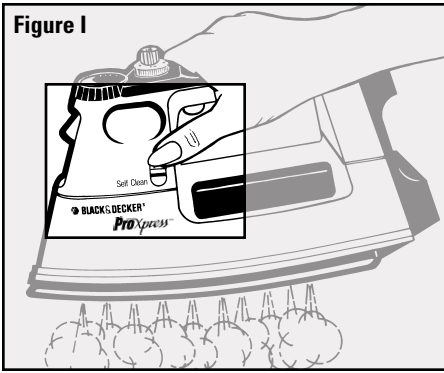

Holding the iron in the ironing position over a sink or basin, press and hold the Self Clean Button down until all the water has been released. This can be done with one or two hands as shown in Figures I and J. Choose the method which is easiest for you.

Place the iron on its Heel Rest and heat for about 2 minutes to dry out any remaining water. Iron over an old towel. Cool as usual.

Figure J

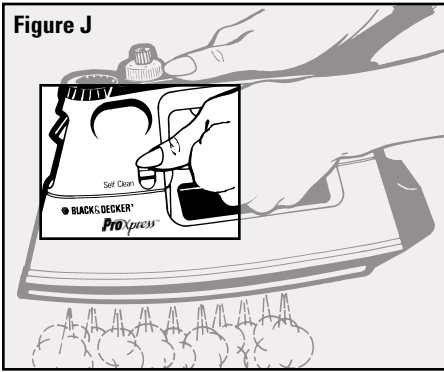

NEED HELP?

IRON WON'T HEAT?



Is the PUSH ON LIGHT on? Push in to turn iron on.

If the Light is not on, will a lamp plugged into the outlet turn on?

Is the Temperature Selector Dial turned to a fabric setting?

IRON WON'T START STEAMING?

Is the PUSH ON Light on and has the iron heated for about 2 minutes?

Check for water by looking in the Water Windows. Is the Adjustable Steam Dial set at , , or ? Adjust the Dial to Dry and back to the desired steam level.

If steaming doesn't start, gently tap the Soleplate on the ironing board once or twice.

WATER DROPLETS COMING FROM STEAM VENTS?

Is the PUSH ON Light on and has the iron heated for about 2 minutes?

Is the Temperature Selector Dial set in a steam area and is the Adjustable Steam Dial set at the corresponding ㉞, ㉟ ㉞, or ㉟ ㉞ ㉞ ?

SERVICE OR REPAIR

Service, if necessary, must be performed by a Black & Decker (U.S.) Inc., Household Appliance Company-Owned or Authorized Service Center. The Service Center nearest you can usually be found in the yellow pages of your phone book under "Electric Appliances-Small-Repairing." For your convenience a complete listing of our Company-Owned Service Centers is listed on pages 13-14.

Before shipping or mailing your iron, empty all water from the iron. Plug in the cord and heat the iron at the maximum temperature setting. Iron continuously over an all cotton cloth for about 5 minutes. Then place the iron on its Heel Rest and leave it operating for 7 to 8 minutes. These steps will help to dry the inside of the iron.

Turn the iron off, move the Adjustable Steam Dial to Dry and be sure the iron is completely cool before packing for shipment. Pack it carefully into a sturdy carton with enough packing material to prevent damage. The original carton is not suitable for mailing. Include a note describing the problem to our Service Center and be sure to give your return address. We also suggest that you insure the package for your protection.

TWO-YEAR WARRANTY

Black & Decker (U.S.) Inc. warrants this product against any defects that are due to faulty material or workmanship for a two-year period after the original date of consumer purchase or receipt as a gift. This warranty does not include damage to the product resulting from accident or misuse.

If the product should become defective within the warranty period, we will repair it or elect to replace it free of charge, including free return transportation, provided it is delivered prepaid to any Black & Decker (U.S.) Inc., Household Appliance Company-Owned or Authorized Service Center.

This warranty gives you specific legal rights, and you may also have other rights which vary from state to state.

Answers to any questions regarding warranty service/locations may be obtained by writing:

Consumer Assistance and Information
Black & Decker (U.S.) Inc.
6 Armstrong Road
Shelton, CT 06484-4797



PROPER DISPOSAL TO PROTECT THE ENVIRONMENT

The automatic shut-off system in this iron has a switch which contains a small amount of mercury. This iron must not be placed in the garbage until the mercury switch has been removed for recycling. Please help Black & Decker protect the environment by returning this iron to any Black & Decker (U.S.) Inc., Company-Owned Service Center for proper disposal or call 800-231-9786.

Listed By Underwriters Laboratories Inc.
Copyright © 1991, 1992, 1993 Black & Decker
Printed in Singapore
Pub. No. 168640-25-RV00