

PowerXL™

products that excel

VORTEX DUAL-BASKET AIR FRYER



Owner's Manual

Save These Instructions - For Household Use Only

MODEL: DUA-F-10 (10 qt.)

When using electrical appliances, basic safety precautions should always be followed. Do not use the **PowerXL Vortex Dual-Basket Air Fryer™** until you have read this manual thoroughly.

Visit [TristarCares.com](https://www.TristarCares.com) for tutorial videos, product details, and more.
Guarantee Information Inside



PowerXL Vortex Dual-Basket Air Fryer

BEFORE YOU BEGIN

The ***PowerXL Vortex Dual-Basket Air Fryer*** will provide you many years of delicious family meals and memories around the dinner table. But before you begin, it's very important that you read this entire manual, making certain that you are completely familiar with this appliance's operation and precautions.

Table of Contents

<i>IMPORTANT SAFEGUARDS</i>	4
<i>Parts & Accessories</i>	6
<i>Using the Control Panel</i>	8
<i>Instructions for Use</i>	10
<i>General Cooking Guidelines</i>	15
<i>Troubleshooting</i>	16
<i>Frequently Asked Questions</i>	17
<i>Cleaning & Storage</i>	18
<i>Money-Back Guarantee</i>	19

IMPORTANT SAFEGUARDS

WARNING

PREVENT INJURIES! - CAREFULLY READ ALL INSTRUCTIONS BEFORE USE!

When using electrical appliances, always follow these basic safety precautions.

- 1. READ AND FOLLOW** all instructions carefully.
- 2. NEVER** immerse the main unit housing in water. If the appliance falls or accidentally becomes immersed in water, unplug from wall outlet immediately. Do not reach into liquid if the appliance is plugged in and immersed.
- 3. DO NOT** place the appliance on or near a hot gas or electric burner, or in a heated oven.
- 4. THIS APPLIANCE IS NOT INTENDED FOR** use by persons with reduced physical, sensory, or mental capabilities or lack of experience and knowledge unless they are under the supervision of a responsible person or have been given proper instruction in using the appliance. This appliance is not intended for use by children.
- Close supervision is necessary when any appliance is used by or near children.
- 6. ALWAYS** attach the plug to the appliance first, then plug the cord into the wall outlet. To disconnect, press the Power button to turn the appliance off, then remove the plug from the wall outlet.
- 7. DO NOT** place the appliance in any container or small confined space while the appliance is heated or in operation.
- 8. DO NOT** plug in the power cord or operate the appliance controls with wet hands.
- 9. MAKE SURE** the appliance is properly plugged into a dedicated wall socket without any other appliances on the same outlet.
- 10. NEVER** plug the appliance into an outlet below the surface where the appliance is placed.
11. Should the appliance emit black smoke, **UNPLUG IMMEDIATELY** and wait for smoking to stop before handling the appliance. Allow the appliance to cool and wipe excess oil and grease from the appliance.
- 12. DO NOT** store any materials, other than manufacturer-recommended accessories, in this appliance when not in use.
- 13. WARNING:** To reduce risk of electric shock, cook only using the removable containers trays, racks, etc. provided.
- 14. DO NOT** use aerosol cooking sprays. These sprays will build up on cookware and become difficult to remove while reducing the nonstick cooking performance.
- 15. DO NOT** place or use this appliance near water.
- 16. DO NOT** use outdoors.
17. When cooking, **DO NOT** place the appliance against a wall or within 5 inches of other appliances. **DO NOT** place anything on top of the appliance.
- 18. ALWAYS** operate the appliance on a horizontal surface that is level, stable, and noncombustible with adequate space for airflow.
19. To prevent food contact with the heating elements, do not overfill.
- 20. DO NOT** cover the Air Intake Vent or Hot Air Outlet Vent while the appliance is operating. Doing so will prevent even cooking and may damage the appliance or cause it to overheat.
- 21. NEVER** pour oil into the Basket. Fire and personal injury could result.
22. While cooking, the internal temperature of the appliance reaches several hundred degrees Fahrenheit. To avoid personal injury, **NEVER** place hands inside the appliance unless it is thoroughly cooled down.
- 23. DO NOT** operate any appliance if it has a damaged cord or plug, if it is not working properly, or if it has been damaged or dropped. Return appliance to an authorized service facility for examination, repair, or adjustment.
24. This appliance should be serviced **ONLY** by qualified service technicians. Contact Customer Service using the information located on the back of this manual.
- 25. KEEP** the appliance and its power cord out of the reach of children when it is in operation or in the cooling down process.
- 26. KEEP** the power cord away from hot surfaces. Do not plug in the power cord or operate the appliance controls with wet hands.
27. To protect against electrical shock, **DO NOT** immerse the cord or plugs or expose the electrical components to water or other liquid.
- 28. NEVER** connect this appliance to an external timer switch or separate remote-control system.
29. The use of accessory attachments not recommended by the appliance manufacturer may cause injuries.
- 30. UNPLUG** the appliance from outlet when not in use and before cleaning. **ALLOW** to cool before handling, putting on or taking off parts, cleaning, or storing.
- 31. DO NOT** let the power cord hang over the edge of a table or counter, or touch hot surfaces.
32. A fire may occur if this appliance is covered by or touching flammable material, including curtains, draperies, walls, and the like, when in operation.
- 33. DO NOT** store any materials other than manufacturer-recommended accessories in this appliance when not in use.
- 34. DO NOT USE** the appliance for any purpose other than described in this manual.
- 35. NEVER** operate the appliance unattended.
36. When in operation, hot air and steam is released through the Hot Air Outlet Vent. **KEEP** your hands and face at a safe distance from the Hot Air Outlet Vent and **KEEP** the Vent clear of obstructions.
37. The appliance's outer surfaces may become hot during use. The Basket and Fry Tray will be hot and may release hot air and steam when opened. **WEAR** oven mitts when handling hot components or touching hot surfaces.
- 38. DO NOT** touch hot surfaces. Use handles or knobs.
39. Before using your new appliance on any countertop surface, **CHECK** with your **COUNTERTOP** manufacturer or installer for recommendations about using appliances on your surfaces. Some manufacturers and installers may recommend protecting your surface by placing a hot pad or trivet under

IMPORTANT SAFEGUARDS

the appliance for heat protection. Your manufacturer or installer may recommend that hot pans, pots, or electrical appliances should not be used directly on top of the countertop. If you are unsure, place a trivet or hot pad under the appliance before using it.

40. **DO NOT** place your appliance on a **COOKTOP**, even if the cooktop is cool, because you could accidentally turn the cooktop on, causing a fire, damaging the appliance, your cooktop, and your home. 
41. Should the appliance emit black smoke, **UNPLUG IMMEDIATELY** and wait for smoking to stop. Allow the appliance to cool and wipe out excess oil and grease from the appliance.
42. **EXTREME CAUTION MUST BE USED** when moving an appliance containing hot oil or other hot liquids or when removing accessories or disposing of hot grease. This appliance is not intended for deep-frying foods.
43. **DO NOT** clean with metal scouring pads. Pieces can break off the pad and touch electrical parts, creating risks of electric shock.
44. Oversized foods, metal foil packages, or utensils **MUST NOT** be inserted in the appliance as they may involve a risk of fire or electric shock. **DO NOT** overfill the appliance.
45. **NEVER** pour oil into the Basket. Fire and personal injury could result.

46. **DO NOT** expose the appliance to corrosive chemicals or vapors.
47. **DO NOT** use sharp utensils with the appliance. These implements can damage the appliance's protective non-stick coating.
48. When cleaning the appliance interior, use **ONLY** mild, nonabrasive soaps or detergents applied with a sponge or soft cloth.
49. **DO NOT** use this appliance for anything other than its intended use.
50. This appliance is for home use only. If the appliance is used improperly or for professional or semi-professional purposes or if it is not used according to the instructions in the user manual, the guarantee becomes invalid and Tristar will not be held liable for damages.
51. **SAVE** this instruction manual.



WARNING:

For California Residents

This product can expose you to Di(2-ethylhexyl)phthalate, which is known to the State of California to cause cancer and birth defects or other reproductive harm. For more information go to www.P65Warnings.ca.gov.

SAVE THESE INSTRUCTIONS – FOR HOUSEHOLD USE ONLY

CAUTION

- **NEVER** rest anything on the baskets while they are open.
- **DO NOT** leave the baskets open for an extended period.
- **ALWAYS** ensure that nothing is protruding out of the appliance before closing the baskets.
- **ALWAYS** close the baskets gently; **NEVER** slam the baskets closed. **ALWAYS** use the handles when opening and closing the baskets.
- **NEVER** operate your appliance with the baskets open.
- When the cooking time has completed, cooking will stop and the fan will continue running for 20 seconds to cool down the appliance.
- Let the appliance cool down for approximately 30 minutes before handling, cleaning, or storing.
- The appliance is equipped with an internal microswitch that automatically shuts down the fan and heating element when the Basket is removed.
- This appliance has a polarized plug (one blade is wider than the other). To reduce the risk of electric shock, this plug is intended to fit into a polarized outlet only one way. If the plug does not fit fully into the outlet, reverse the plug. If it still does not fit, contact a qualified electrician. **DO NOT** attempt to modify the plug in any way.
- **NEVER** use this appliance with an extension cord of any kind. A short power-supply cord is provided to reduce the risk of becoming entangled in or tripping over a longer cord.

Overheating Protection: Should the inner temperature control system fail, the overheating protection system will be activated and the appliance will not function. Should this happen, unplug the appliance. Allow time for the appliance to cool completely before restarting or storing.

Automatic Shut-Off: The appliance has a built-in shut-off device that will automatically shut off the appliance when the cooking time has completed. You can manually switch off the appliance by pressing the Power Button. The fan will continue running for 20 seconds to cool down the appliance.

Electric Power: The appliance should be operated on a dedicated electrical outlet. If the electrical outlet is being used by other appliances, your new appliance may not operate properly.

Electromagnetic Fields: This appliance complies with all standards regarding electromagnetic fields. If handled properly and according to the instructions in this user manual, the appliance is safe to use based on scientific evidence available today.

Parts & Accessories

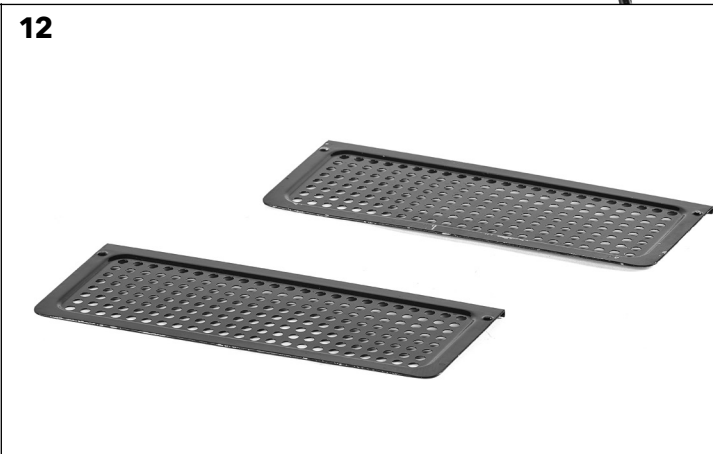
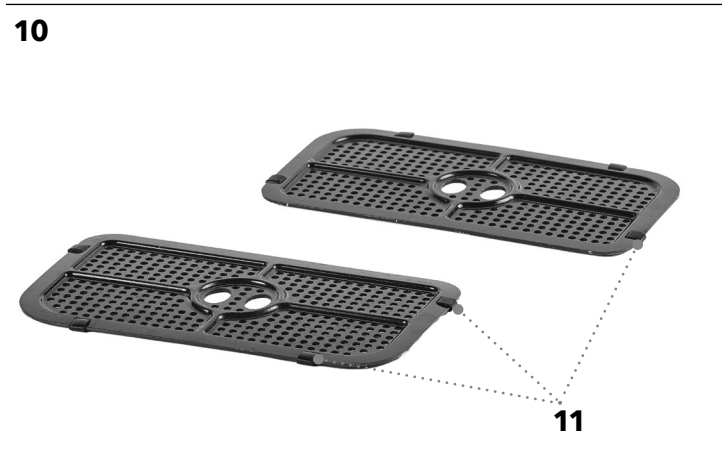
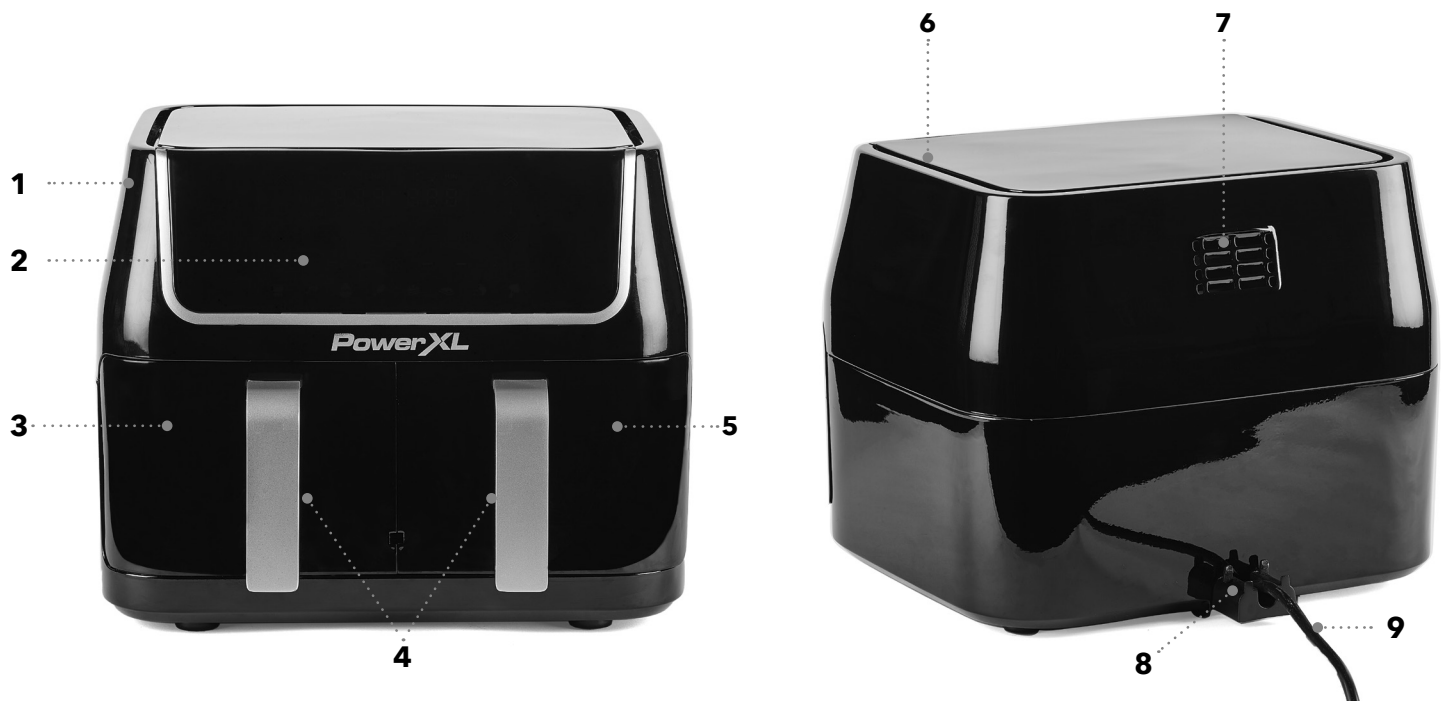

NOTE: Unpack all listed contents from the packaging. Contents vary by model. Please remove any clear or blue protective film on the components before use.

*Removing bumpers is not recommended.

Parts & Accessories

1. MAIN UNIT HOUSING
2. CONTROL PANEL
3. BASKET 1
4. HANDLES
5. BASKET 2
6. AIR INLET VENT
7. HOT AIR OUTLET VENT
8. POWER CABLE
9. PLACE HOLDER FOR U-CHANNEL CONNECTOR
10. FRY TRAYS
11. RUBBER BUMPERS
12. BASKET DIVIDERS
13. U-CHANNEL CONNECTOR

IMPORTANT: Please make sure that your appliance has been shipped with the components that you ordered (some accessories may be sold separately). Check everything carefully before use. If any part is missing or damaged, do not use this product. Contact the shipper using the customer service number located on the back of this manual.

CAUTION: Appliance may be hot. Be careful not to touch the appliance while in use. Keep the appliance away from other objects.



DUAL-BASKET MODE



SINGLE-BASKET MODE

Technical Specifications

Model Number	Supply Power	Rated Power	Full Basket Capacity	Temperature	External Dimensions	Cord Length
DUAF-10	AC 120V ~60Hz	1700W	10 qt. (9.4 liters) for both 5 qt. (4.9 liters) per basket	90° F-400° F (32° C-204° C)	16.9" x 15.8" x 12.8" (42.9 x 40.1 x 32.5 cm)	35" (88.9 cm)

Using The Control Panel

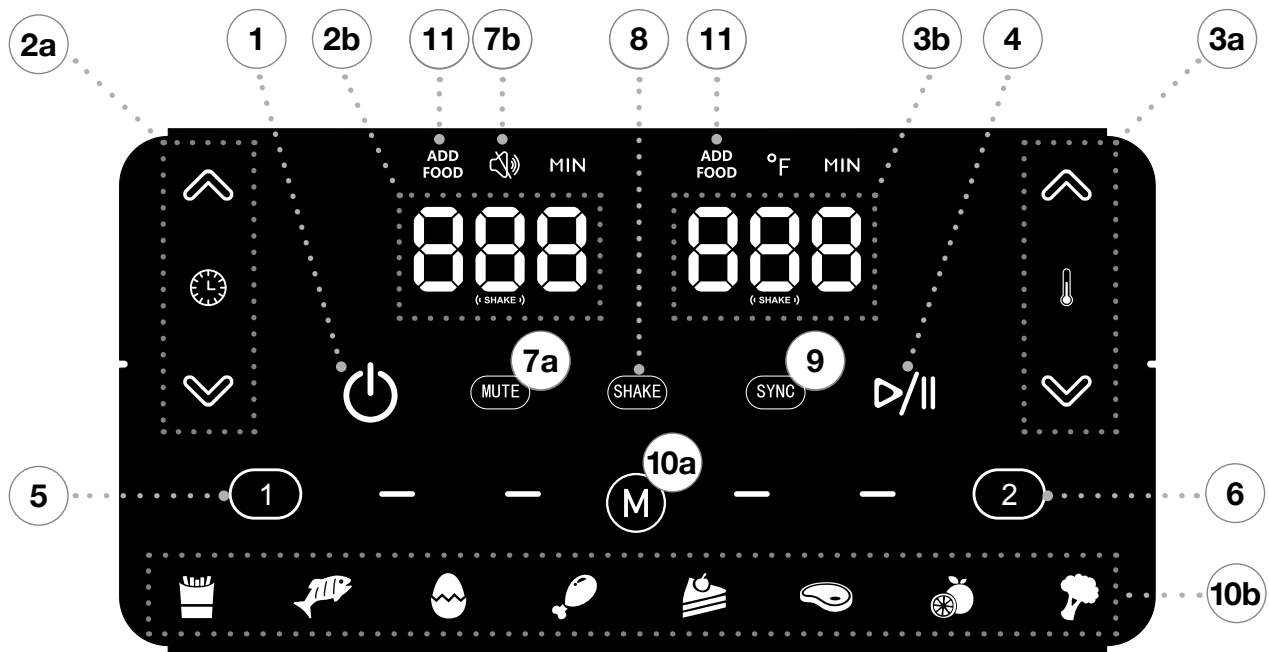

1. Power Button

Press to turn the appliance on or off. Once the Baskets and Fry Trays are properly placed in the Main Unit Housing, the Control Panel will be illuminated. Press the Power Button once to set the unit to a default cooking temperature of 375° F/191° C and a cooking time of 15 minutes.

2a. Timer Control

Press the + and - symbols to increase or decrease the cooking time 1 minute at a time. Hold a button down to rapidly change the time.

2b. Time Indicator

Displays the cook time remaining for the appliance as a whole, or for Basket 1 only in dual-basket mode or Synced mode.

2a. Temperature Control

Press the + and - symbols to increase or decrease cooking temperature 5°F at a time. Hold a button down to rapidly change the temperature. Temperature control range: 180-400° F (82-204° C).

3b. Time/Temperature Indicator

Displays the cooking temperature or the cooking time for Basket 2 (only in dual-basket mode or Synced mode).

4. Start/Pause Button

Press to start, pause, or resume the cooking process.

5. Basket 1 Button

Press to select Basket 1 before setting the cooking time and temperature.

6. Basket 2 Button

Press to select Basket 2 before setting the cooking time.

7a. Mute Button

Press to silence or reenable all sounds, including timer alerts.

7b. Mute Indicator

Indicator turns on if the appliance is muted.

Using The Control Panel

8. Shake Button

Pressing the Shake Button engages the halfway timer. An icon will light up under each display to indicate that the Shake function is active. When the timer is halfway through the original cooking time, the Shake icon will blink and the appliance will beep five times. Then, the Shake icon will darken.

9. Sync Button

Used to finish cooking foods in both baskets at the same time. Press to select the Sync function before setting the cooking settings. When setting the Baskets to different cook times, the higher cooking time will start first. When both baskets' cooking timers synchronize, the appliance will beep five times, indicating that food should be added to the empty basket. Then, both timers will resume.

10a. Menu Selection Button

Press to scroll through the eight available presets.

10b. Preset Buttons









See the "Preset Chart" for time and temperature information.

11. Add Food Indicators

The Add Food icon will illuminate when using the Dual Baskets/Sync function. When the longer cooking time matches the shorter cooking time, the cooking cycle will pause and the Add Food icon will illuminate, indicating the food should be added to the second basket.

Preset Chart

Once you are familiar with the appliance, you may want to experiment with your own recipes. Simply choose the time and temperature that suits your personal taste.

Preset	Temperature	Time
<i>Default</i>	375° F (191° C)	15 mins.
 French Fry	400° F (204° C)	22 mins.
 Fish	390° F (199° C)	10 mins.
 Egg	250° F (121° C)	18 mins.
 Chicken	375° F (191° C)	40 mins.
 Bake	320° F (160° C)	30 mins.
 Steak	400° F (204° C)	12 mins.
 Dehydrate	120° F (49° C)	2 hrs.
 Vegetable	380° F (193° C)	10 mins.

Instructions for Use

Before First Use

1. Read all material, warning stickers, and labels.
2. Remove all packing materials, stickers, and labels from the appliance.
3. Wipe the inside and outside of the appliance with a warm, moist cloth and mild detergent. Rinse with a clean, moist cloth. Never submerge the appliance. Handwash all cooking accessories.
4. Place the appliance on a stable, horizontal, level, and heat-resistant surface. Do not place on the stove top. Ensure that the appliance is used in an area with good air circulation and away from hot surfaces and combustible materials.
5. Before cooking food, preheat the appliance for a few minutes to allow the appliance to burn off the manufacturer's protective coating of oil. Wipe the appliance with warm, soapy water and a washcloth after this burn-in cycle.
6. Place the Fry Trays in the Baskets. Slide the Baskets into the Main Unit Housing. If the Basket is placed properly, it will click into place.

NOTE: This appliance cooks using hot air. Do not fill the Basket with oil or frying fat. Do not put anything on top of the appliance. This disrupts the airflow and affects the cooking results.

Assembling the Baskets

For Double (5-Quart) Baskets

1. Remove the baskets from the Main Unit Housing.
2. If present, lift the Fry Trays from the baskets, and remove the U-Channel Connector.
3. Orient a Basket Divider so that the arrow is outside of the basket and pointing downward (see **Fig. 1**). Push the Basket Divider all the way into the basket's groove slot.
4. Push the Fry Tray into the basket so that Rubber Bumpers are pressed against the bottom of the basket.
5. Repeat steps 3 and 4 for the other basket.

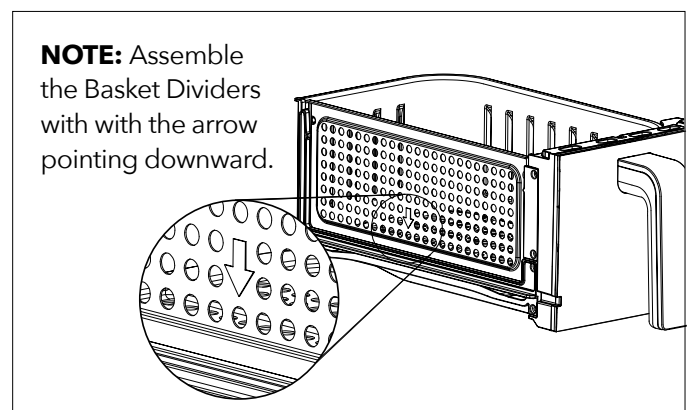

Fig. 1

For Large (10-Quart) Basket

1. Remove the baskets from the Main Unit Housing.
2. If present, lift the Fry Trays from the baskets and remove the Basket Dividers.
3. Place the baskets against each other so that the open sides of the baskets are aligned. Align the U-Channel Connector with the groove slots on both sides of the baskets simultaneously (see **Fig. 2**). Slide both sides of the U-Channel Connector downward at the same time while applying outward pressure to both sides of the U-Channel Connector so that the U-Channel Connector attaches to both groove slots at the same time (see **Fig. 3**).



Fig. 2



Fig. 3

NOTE: To remove the U-Channel Connector, pull it out of position slowly and evenly.

4. Push the Fry Trays into the baskets so that the Rubber Bumpers are pressed against the bottom of the baskets.

Scan this QR code with your tablet or smartphone's camera to watch a quick video tutorial showing you how to assemble the Fry Baskets.



Instructions for Use

Appliance Operation with Single (10-Quart) Basket

Refer to the highlighted buttons in Fig. 4.

1. Fit the Baskets with the U-Channel Connector and Fry Trays to assemble the large 10-quart basket. Place the basket into the Main Appliance Housing.
2. Plug the appliance into a grounded wall socket. Press the Power Button (a) to turn the appliance on.
3. To preheat the appliance:
 - a. Press the Temperature Control Buttons (b) to set the cooking temperature.
 - b. Press the Time Control Buttons (c) to set the preheat time to 3 minutes.
 - c. Press the Start/Pause Button (d) to begin preheating.
4. Press the Menu Selection Button (f) to scroll through the cooking presets and select a preset time and temperature, or press the Timer Control (c) and Temperature Control Buttons (b) to manually set a time and temperature.
5. **Optional:** Press the Shake Button (e) to activate the Shake feature, indicated by the "Shake" LED illuminating under the left timer. If active, when the cooking time is halfway completed, the icon will blink five times.
6. Carefully pull the basket out of the appliance, place the ingredients inside, and push the basket all the way back into the appliance. **DO NOT** touch the basket directly; only hold the basket by the handles.
NOTE: For better performance, always use the Fry Trays with the basket.
7. Press the Start/Pause Button (c) to start the cooking cycle.

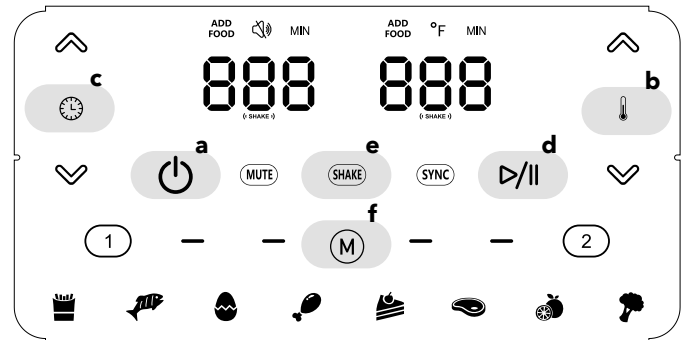

Fig. 4

8. When the buzzer prompt activates, the set cooking time has elapsed. Carefully remove the basket from the appliance and place it on a heat-resistant surface.
9. If the food is fully cooked, use tongs to remove food. The appliance is instantly ready for preparing another batch.
CAUTION: Do not turn the baskets upside down. Any excess oil that has collected on the bottom of the basket will leak onto the ingredients and may splash onto you and your surroundings.
10. If the food is not fully cooked, simply slide the basket back into the appliance and cook for another few minutes.
NOTE: The appliance may be operated with a single 5-quart basket. Simply fit the baskets with the Basket Dividers and Fry Trays for the first step and fill only one basket with food.

Instructions for Use

Appliance Operation with Dual (5-Quart) Baskets

This procedure explains how to operate the appliance. The foods for each basket will start cooking at the same time and may complete separately. Refer to the highlighted buttons in **Fig. 5**.

1. Fit the baskets with the Basket Dividers and Fry Trays to assemble the dual 5-quart baskets. Place the baskets into the Main Appliance Housing.
2. Plug the appliance into a grounded wall socket. Press the Power Button (**a**) to turn the appliance on.
3. To preheat the appliance:
 - a. Press the Temperature Control Buttons (**b**) to set the cooking temperature.
 - b. Press the Time Control Buttons (**c**) to set the preheat time to 3 minutes.
 - c. Press the Start/Pause Button (**d**) to begin preheating.
4. Press the Menu Selection Button (**f**) scroll through the Preset Buttons to select a preset time and temperature or press the Timer Control (**c**) and Temperature Control Buttons (**b**) to manually set a time and temperature.
5. Press the Basket 2 Button (**h**). Then, press the Timer Control Buttons (**c**) to manually set a different cooking time for Basket 2.
6. **Optional:** Press either the Basket 1 (**g**) or Basket 2 (**h**) Button, then press the Shake Button (**e**) to activate the Shake feature for the selected basket, indicated by the "Shake" LED illuminating under the left or right timer. If active, when the cooking time is halfway completed, the icon will blink five times.

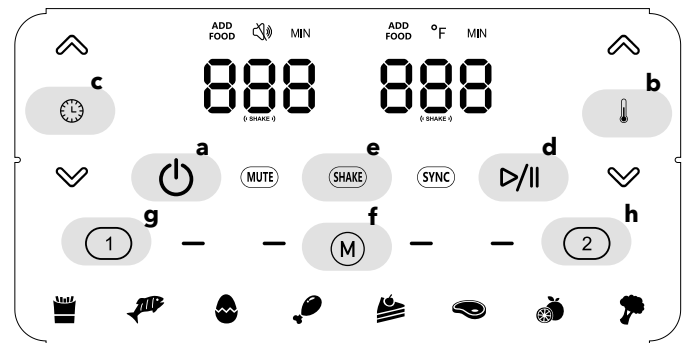

Fig. 5

7. Carefully pull the baskets out of the appliance, place the ingredients inside, and push the baskets all the way back into the appliance. **DO NOT** touch the baskets directly; only hold the baskets by the handles. **NOTE:** For better performance, always use the Fry Trays with the basket.
8. Press the Start/Pause Button (**d**) to start the cooking cycle.
9. When the buzzer prompt activates, the set cooking time has elapsed. The cooking time will pause for the other basket if it was still running. Carefully remove the basket from the appliance and place it on a heat-resistant surface.
10. If the food is fully cooked, use tongs to remove food. Push the basket back into the appliance to resume cooking for the other basket if it was paused. **CAUTION:** Do not turn the baskets upside down. Any excess oil that has collected on the bottom of the basket will leak onto the ingredients and may splash onto you and your surroundings.
11. If the food is not fully cooked, simply slide the basket back into the appliance and cook for another few minutes.

Instructions for Use

Synchronized Appliance Operation with Dual (5-Quart) Baskets

This procedure explains how to operate the appliance with the “Sync” function. The foods for each basket will start cooking separately to complete at the same time. Refer to the highlighted buttons in **Fig. 6**.

1. Fit the baskets with the Basket Dividers and Fry Trays to assemble the dual 5-quart baskets. Place the baskets into the Main Appliance Housing.
2. Plug the appliance into a grounded wall socket. Press the Power Button (**a**) to turn the appliance on.
3. To preheat the appliance:
 - a. Press the Temperature Control Buttons (**b**) to set the cooking temperature.
 - b. Press the Time Control Buttons (**c**) to set the preheat time to 3 minutes.
 - c. Press the Start/Pause Button (**d**) to begin preheating.
4. Press the Basket 1 Button (**g**) to select Basket 1. Press the Menu Selection Button (**f**) and then one of the Preset Buttons to select a preset time and temperature or press the Timer Control (**c**) and Temperature Control Buttons (**b**) to manually set a time and temperature.
5. Press the Basket 2 (**h**) Button. Then, press the Timer Control Buttons (**c**) to manually set a different cook time for Basket 2.
6. **Optional:** Press either the Basket 1 (**g**) or Basket 2 (**h**) Button, then press the Shake Button (**e**) to activate the Shake feature for the selected basket, indicated by the “Shake” LED illuminating under the left or

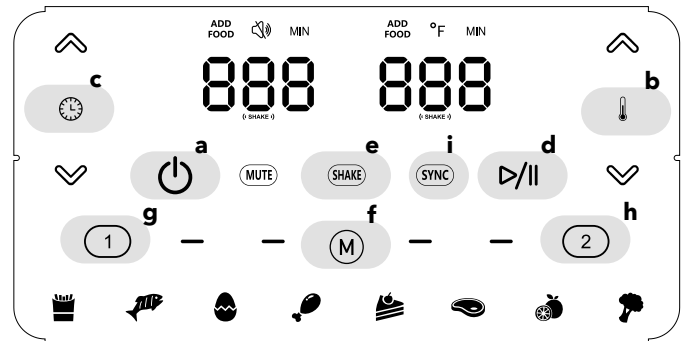

Fig. 6

- right timer. If active, when the cooking time is halfway completed, the icon will blink five times.
7. Select the basket programmed with the **LONGEST** cooking time **ONLY**. Carefully pull the basket out of the appliance, place the ingredients inside, and push the basket all the way back into the appliance.
8. Press the Sync Button (**i**) to synchronize the cooking timers. Press the Start/Pause Button (**d**) to start the cooking cycle.
9. When the buzzer prompt activates, the cooking timers have synchronized and the timers will pause. Carefully remove the empty basket, fill with food, and push the basket back into the appliance to resume cooking.
10. When the buzzer prompt activates again, the set cooking time has elapsed. Carefully remove the baskets from the appliance and place them on a heat-resistant surface.
11. If the food is fully cooked, use tongs to remove food. The appliance is instantly ready for preparing another batch.
CAUTION: Do not turn the baskets upside down. Any excess oil that has collected on the bottom of the basket will leak onto the ingredients and may splash onto you and your surroundings.
12. If the food is not fully cooked, simply slide the basket back into the appliance and cook for another few minutes.

Instructions for Use

Shake Function

To ensure even cooking, some foods require shaking during the cooking process. This can be done automatically by pressing the Shake Button after selecting a basket, before starting the cooking process. The appliance will beep five times when the timer is halfway done.

Alternatively, this may be done manually.

CAUTION: The basket will be hot. Wear an oven mitt during this procedure.

1. Press the Start/Pause Button to pause cooking.
2. Remove the basket and place on a heat-resistant surface.
3. Shake the ingredients in the basket.
4. Return the basket to the appliance.
5. Press the Start/Pause Button to resume cooking.

Tips

- Foods that are smaller in size usually require a slightly shorter cooking time than larger ones.
- Misting a bit of vegetable oil on breaded food is suggested for a crispier result. When adding oil, add only a little just before cooking.
- Snacks normally cooked in an oven can also be cooked in the appliance.
- Use premade dough to prepare filled snacks quickly and easily. Premade dough also requires a shorter cooking time than homemade dough.
- Place fragile or filled foods in a baking tin or oven dish in the appliance. A baking tin or oven dish is also suggested when baking a cake or quiche.
- You can use the appliance to reheat foods. Simply set the temperature and time to however warm you want your food.
- Wear oven mitts/gloves to protect against accidental contact with the heated surfaces and escaping hot air and steam from opening the appliance.
- To prevent scratching the nonstick coating, use only nonmetallic utensils. Do not lift or cut food in the appliance using sharp utensils, such as forks and knives, which can scratch the cooking surface.
- Do not use steel wool or other metal pads on the appliance. These could leave coarse scratches or create electrical hazards.

General Cooking Guidelines

NOTE: Keep in mind that these settings are guidelines. Times may vary. Since ingredients differ in origin, size, shape, and brand, we cannot guarantee the best settings for your ingredients.

Food item	Size	Temperature	Cook Time	Preheat	Shake or Flip	Spray with Oil
FROZEN FOOD						
French fries		400° F (204° C)	18 mins.		✓	
Sweet potato fries		400° F (204° C)	22 mins.		✓	
Chicken nuggets		400° F (204° C)	14 mins.		✓	
CHICKEN						
Breaded cutlets	6 oz	400° F (204° C)	10 mins.	✓	✓	✓
Wings		400° F (204° C)	25 mins.	✓	✓	
Chicken breast	6 oz	400° F (204° C)	8 mins.	✓		
BEEF						
Burgers	6 oz	400° F (204° C)	10 mins.	✓	✓	
Hot dogs	8 pc	375° F (191° C)	5 mins.	✓	✓	
NY strip steaks	8 oz	400° F (204° C)	12 mins.	✓	✓	
Meatballs, 1 inch	1.5 lb	375° F (191° C)	10 mins.	✓	✓	
PORK						
Pork chops		400° F (204° C)	12 mins.	✓	✓	
Sausages		350° F (177° C)	15 mins.	✓	✓	
FISH						
Salmon filets	6 oz	390° F (199° C)	12 mins.	✓		
Shrimp (16–20 size)	12 oz	390° F (199° C)	10 mins.	✓	✓	
VEGETABLES						
Asparagus	1 lb	380° F (193° C)	8 mins.		✓	✓
Broccoli	8 oz	380° F (193° C)	8 mins.		✓	✓
Corn on the cob	2 pc	380° F (193° C)	8 mins.		✓	✓
PREPARED FOOD						
Hard boiled eggs, shell on		250° F (121° C)	18 mins.			
Cake		320° F (160° C)	20 mins.			
Grilled cheese sandwich	1 pc	375° F (191° C)	6 mins.	✓	✓	

Troubleshooting

Symptom	Possible Cause	Solution
The appliance does not work	The appliance is not plugged in.	Plug the Power Cable into a wall socket.
	You have not turned the appliance on by setting the preparation time and temperature.	Press the Power Button. Select a time and temperature. Press the Power Button again and cooking will begin.
	You have probably turned the appliance off. If you press the Power Button while the appliance is cooking, you will trigger the Auto Shut-Off mode.	Press the Power Button. Select a time and temperature. Press the Power Button again and cooking will begin.
Food is not cooked	The basket is overloaded.	Use smaller batches for more even frying.
	The temperature is set too low.	Raise temperature and continue cooking.
Food is not fried evenly	Some foods need to be shaken during the cooking process.	See "Shake Function" in the "Instructions for Use" section.
	Foods of different sizes are being cooked together.	Cook similar-sized foods together.
Basket will not slide into appliance properly	The basket is overloaded.	Do not fill the basket above the Maximum line.
	The Fry Tray is not placed in the basket correctly.	Gently push the Fry Tray into the basket until it clicks.
White smoke coming from appliance	Too much oil is being used.	Wipe down to remove excess oil.
	The basket has grease residue from the previous operation.	Clean the basket after each use.
French fries are not fried evenly	Potatoes are not prepped properly.	Consult a recipe for potato type and prep.
	Fries are not cut evenly.	Cut fries thinner or reshape fries.
	Fries are too crowded.	Spread fries out or cook a smaller batch.
	Potatoes are not rinsed properly during preparation.	Pat dry to remove excess starch.
Fries are not crispy	Raw fries have too much water.	Dry potato sticks properly before misting oil.
		Cut sticks smaller.
		Add a bit more oil.
Error	E1 - Broken circuit of the thermal sensor	Call Customer Service at 1-973-287-5129
	E2 - Short circuit of the thermal sensor	

Frequently Asked Questions

- 1. Can I prepare foods other than fried dishes with my appliance?** You can prepare a variety of dishes, including steaks, chops, burgers, and baked goods. See the Recipe Guide.
- 2. Is the appliance good for making or reheating soups and sauces?** Never cook or reheat liquids in the appliance.
- 3. Is it possible to shut off the appliance at any time?** Press the Power Button once or remove the basket.
- 4. What do I do if the appliance shuts off while cooking?** As a safety feature, the appliance has an Auto Shut-Off device that prevents damage from overheating. Unplug and allow the appliance to cool down. Plug back in and restart with the Power Button.
- 5. Does the appliance need time to heat up?** If you are cooking from a cold start, add 3 minutes to the cooking time to compensate.
- 6. Can I check the food during the cooking process?** You can remove the basket at any time while cooking is in progress. During this time, you can shake the contents in the basket if needed to ensure even cooking.
- 7. How do I stop the cooking time in 1 zone while using it as a Dual Zone Air Fryer?** Press the Start/Pause button, then Hold the Basket # you want to cancel for 5 seconds. The Basket Display will then read OFF.
- 8. Is the appliance dishwasher safe?** Only the Fry Tray is dishwasher safe. The appliance itself, which contains the heating coil and electronics, should never be submerged in liquid of any kind or cleaned with anything more than a warm, moist cloth or nonabrasive sponge with a small amount of mild detergent.
- 9. What happens if the appliance still does not work after I have tried all the troubleshooting suggestions?** Never attempt a home repair. Contact customer service and follow the procedures set forth by the guarantee. Failure to do so could render your guarantee null and void.

Cleaning & Storage

Cleaning

Clean the appliance after each use. The baskets and the Fry Tray are coated with a special nonstick surface. Never use abrasive cleaning materials or utensils on these surfaces. **DO NOT** soak or submerge the appliance in water or wash in a dishwasher.

1. Remove the Power Cable from the wall socket and be certain the appliance is thoroughly cooled before cleaning.
2. Wipe the outside of the appliance with a warm, moist cloth and mild detergent.
3. Clean the baskets and the Fry Tray with hot water, a mild detergent, and a nonabrasive sponge.
NOTE: The Fry Tray is dishwasher safe.
TIP: Should the Fry Tray contain difficult-to-remove food particles, soak in hot, soapy water for 10 minutes.

NOTE: The rubber bumpers on the Fry Tray are part of the Fry Tray and should generally not be removed. However, if the rubber bumpers need to be cleaned, they can be removed and reattached: To remove the rubber bumpers, locate the capped end of the

bumpers and push the capped end off of the Fry Tray. There will be some resistance, but keep pushing until the rubber bumpers come off of the Fry Tray. Take note of the slot on which the bumpers were sitting. To reattach the rubber bumpers, align the hole in the rubber bumpers with the slots from which the rubber bumpers were removed. Slide the rubber bumpers all the way back onto the slot on the Fry Tray.

4. Clean the inside of the appliance with hot water, a mild detergent, and a nonabrasive sponge.
5. If necessary, remove unwanted food residue from the heating element with a soft cleaning brush.
6. Rinse the appliance with a clean, damp cloth. Use a clean, dry cloth to dry the appliance interior. Do not leave standing water in the appliance.
7. If any other service needs to be performed, contact Customer Service, using the contact information on the back of this manual.

Storage

1. Unplug the appliance and let it cool down thoroughly.
2. Make sure all components are clean and dry.
3. Place the appliance in a clean, dry place.



NOTE: For storage, the U-Channel Connector may be mounted on the placeholder on the back of the appliance as shown.

PowerXL[™] products that excel

VORTEX DUAL-BASKET AIR FRYER

90-Day Money-Back Guarantee

The PowerXL Vortex Dual-Basket Air Fryer Pro is covered by a 90-day money-back guarantee. If you are not 100% satisfied with your product, return the product and request a replacement product or refund. Proof of purchase is required. Refunds will include the purchase price, less processing and handling. Follow the instructions in the Return Policy below to request a replacement or refund.

Replacement Guarantee Policy

Our products, when purchased from an authorized retailer, include a 1-year replacement guarantee if your product or component part does not perform as expected, the guarantee extends only to the original purchaser and is not transferable. If you experience an issue with one of our products within 1 year of purchase, return the product or the component part for replacement with a functionally equivalent new product or part. The original proof of purchase is required, and you are responsible to pay to return the appliance to us. In the event a replacement appliance is issued, the guarantee coverage ends six (6) months following the receipt date of the replacement appliance or the remainder of the existing guarantee, whichever is later. Tristar reserves the right to replace the appliance with one of equal or greater value.

Return Policy

If, for any reason, you would like to replace or return the product under the money-back guarantee, your order number can be used as the return merchandise authorization number (RMA). If the product was purchased in a retail store, return the product to the store or use "RETAIL" as the RMA. Return your product to the address provided below for a replacement, which will incur no additional processing and handling fees, or for the refund of your purchase price, less processing and handling. You are responsible for the cost of returning the product. You can locate your order number at www.customerstatus.com. You can call customer service at 973-287-5129 or email info@tvcustomerinfo.com for any additional questions. Pack the product carefully and include in the package a note with (1) your name, (2) mailing address, (3) phone number, (4) email address, (5) reason for return, and (6) proof of purchase or order number, and (7) specify on the note whether you are requesting a refund or replacement. Write the RMA on the outside of the package.

Send the product to the following return address:

PowerXL Vortex Dual-Basket Air Fryer Pro
Tristar Products
500 Returns Road
Wallingford, CT 06495

If the replacement or refund request has not been acknowledged after two weeks, please contact Customer Service at 973-287-5129.

Refund

Refunds requested within the money-back guarantee timeframe will be issued to the payment method used at purchase if the item was purchased directly from Tristar. If the item was purchased from an authorized retailer, proof of purchase is required, and a check will be issued for the item and sales tax amount. Processing and handling fees are non-refundable.

PowerXL™
products that excel

VORTEX DUAL-BASKET AIR FRYER

We are very proud of the design and quality of our
PowerXL Vortex Dual-Basket Air Fryer™.

This product has been manufactured to the highest standards. Should you have any questions, our friendly customer service staff is here to help you.

For parts, recipes, accessories, and everything PowerXL, go to tristarcares.com or scan this QR code with your smartphone or tablet:

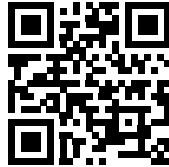

To contact us,
email us at info@tvcustomerinfo.com
or call us at 973-287-5129.



Distributed by:
Tristar Products, Inc.
Fairfield, NJ 07004
© 2021 Tristar Products, Inc.

Made in China

PXL-VDBAF-DUAF-10_IB_TP_ENG_V2_211109

